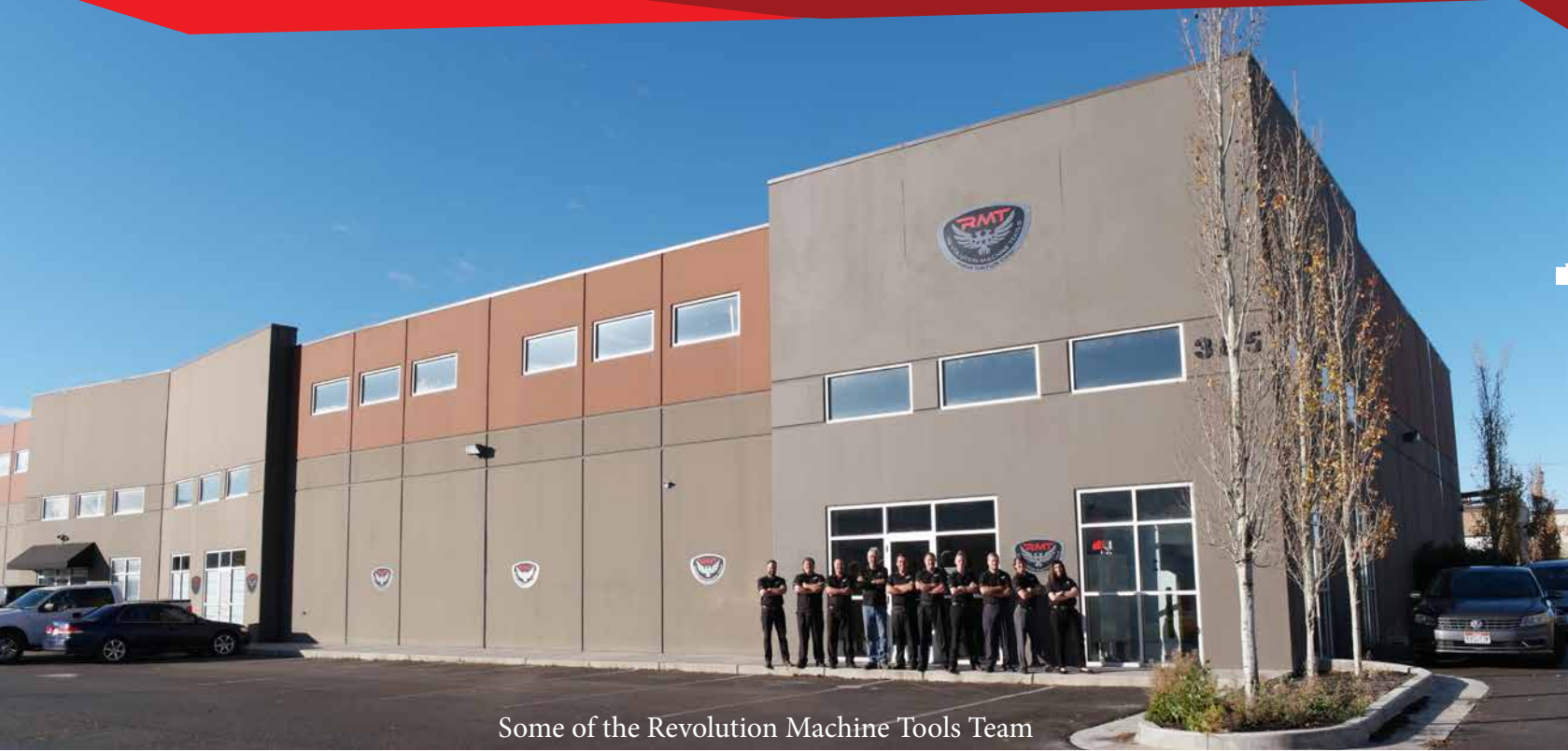



PLATE ROLL

ECO, SMART, GIANT,
HYBRID SERIES





Some of the Revolution Machine Tools Team

ABOUT REVOLUTION MACHINE TOOLS

Revolution Machine Tools (RMT), founded by long time industry leader Kyle Jorgenson, is a metal fabrication machine tools company. RMT's design team has created the most innovative and precise tools in the North American market today. We are partners with leading manufacturers who build our designs to our stringent specifications in state of the art manufacturing facilities.

Kyle Jorgenson started in the Machine Tool industry working with his father, Roger Jorgenson, who founded Jorgenson Machine Tools in 1974. Roger taught Kyle how important relationships and customer service are, and Kyle has built his reputation on those principles. Revolution Machine Tools is supported by an ever expanding team of industry professionals, which include design, marketing, service and support, who have these same values and respect Kyle's vision. Together, they are creating a revolution in the Machine Tool industry.

RMT's main focus is in large cutting, forming, and rolling machines for the metal fabrication industry. RMT's research and development team has created the most innovative, fast, durable and accurate machines in the industry. Our machines are all backed by a strong warranty and an outstanding service team dedicated to keeping your machines operational. We understand the time value of money and how expensive downtime can be.





PRE-SALE CONSULTATION

RMT's commitment to service begins with our site assessment consultation, before we even discuss purchasing equipment. We start by making an assessment of your production area to determine whether the equipment will work well in your manufacturing environment. We look at where the equipment will be placed on the production floor, how it will be brought into the facility, and even ways to make the disposal of scrap and waste easier to remove. We will also recommend the proper installation of our equipment, or we can even come install it for you. More importantly, we can verify adequate electrical, pneumatic or hydraulic requirements and we look at the surrounding equipment to assess if there are any electro-magnetic or vibration interference issues.

Kyle Jorgenson / President



Atakan Nerminer / R&D Manager



REVOLUTIONARY SERVICE

QUALIFIED SERVICE TECHNICIANS

Join the Revolution with service technicians from Revolution Machine Tools that can maintain, troubleshoot and fix your machines. Our goal at RMT is to ensure our customers experience smooth operations and greater return on investment by having their machines repaired and maintained by qualified personnel who are committed to the customer's success.

The service team at Revolution Machine Tools is experienced and able to diagnose, repair and install your equipment when you need it. Twenty-four hours a day, you will reach a live service technician 365 days out of the year. We know that you can't wait for days or weeks to keep your production deadlines, and we are committed to minimizing your downtime and keeping your manufacturing processes moving forward.

PREVENTATIVE MAINTENANCE PROGRAM

Keeping your machines operating at their peak performance is key to successful manufacturing. At Revolution Machine Tools, we have the right preventative maintenance plan to fit your needs; thus, keeping your machines performing at their most efficient levels.



Our service technicians will create the perfect preventative maintenance plan for you. They will evaluate your machines, and provide you with a customized maintenance plan. Each plan will include general maintenance, safety evaluations, suggested repairs and part replacement.

SERVICE WHEN YOU NEED IT

Twenty-four hours a day, seven-days a week, you can count on Revolution Machine Tools to be there when you need them. How many times have you needed customer service for a machine breakdown? Each and every breakdown equates to a loss in opportunity cost and profit. At Revolution Machine Tools, we are committed to making sure you get the most out of your equipment, and when it does breakdown, providing repair services in a timely manner.

So, if you are in need of a troubleshooting or repair, you can call our service team anytime, 24-hours a day/7-days a week. Anytime you run into a machine problem, you can reach a service technician by phone or e-mail and we will answer or respond.. You don't need help in two days, you need it now.



SERVICE HOTLINE
844-RMT-SERV (768-7378)

SERVICE@RMTUS.COM



PARTS & TOOLING

SUPERIOR PARTS AND TOOLING

Every machine used in the chipping, fabrication and forming of metal has consumables and tooling to keep them performing efficiently. These consumables and tools range from hydraulic oil, laser nozzle tips, replacement parts, software and more. Making sure you have the right products to take care of your machines is what we at Revolution Machine Tools specialize in. We stock the highest grade consumables, replacement parts and tooling to fit your needs; and, if on the rare occasion we don't have the part, we most likely know where to find it.

Our parts and tooling department is constantly looking for ways to maximize the potential of your machines. Specialized tooling can be ordered and shipped to your location. We have qualified customer service representatives who can help you find solutions and answers to your manufacturing needs.

Revolution Machine Tools and its staff are committed to providing you the most effective service possible. We encourage you to call, even if we don't carry your brand of machine, and see if we can support you in making sure you have the right parts and tooling to fulfill your production goals and needs.



Talip, Parts and Tooling Manager

REPLACEMENT PARTS AND ACCESSORIES



SWITCHES



GEARS AND BEARINGS



ELECTRICAL COMPONENTS



R-ECO SERIES



These initial pinch rolls are designed for small bending with low operation cost. R-ECO rolls feature robust cast iron frames (or steel welded frame depending on size), chain and gearbox drive systems and electric motors with a magnetic break which eliminates drifting. They also offer foot pedals with forward, reverse, and emergency stop along with a safety wire and limit switch. A very economical, reliable, and efficient choice for your small parts needs. See pages 10 - 15



R-ECO-A Series

Motorized Initial Pinch Three Roll

**3' ~ 6' Bending Lengths
2.67" ~ 2.95" Top roll diameter
Up 14 Ga Capacity**



R-ECO-B Series

Motorized Initial Pinch Three Roll

**3' ~ 6' Bending Lengths
3.54" ~ 3.93" Top roll diameter
Up 10 Ga Capacity**



R-ECO-C Series

Motorized Initial Pinch Three Roll

**3' ~ 8' Bending Lengths
4.33" ~ 5.51" Top roll diameter
Up 5 Ga Capacity**



R-ECO-D Series

Motorized Initial Pinch Three Roll

**3' ~ 10' Bending Lengths
5.90" ~ 7.08" Top roll diameter
Up 3/8" Capacity**

PLATE ROLL SERIES



R-SMART Series

Planetary Type Hydraulic Four Roll

4' ~ 14' Bending Lengths

5.51" ~ 16.93" Top roll diameter

1/8" ~ 1-3/4" Capacity

The R-SMART series 4 Roll plate rolls are developed specifically for the most demanding applications. Achieve obtainable production speeds that have never been realized before.

Available with NC and CNC applications

See pages 28 - 31



R-GIANT Series

Rectilinear Type Hydraulic Four Roll

6' ~ 14' Bending Lengths

18.11" ~ 29.92" Top roll diameter

3/4" ~ 3-1/2" Capacity

The R-GIANT series 4 Roll plate rolls are built for extreme precision and full CNC applications. These machines are built for production and speed, creating a perfect balance. These machines are the culmination of our many years of experience.

See pages 32 - 35



R-HYBRID Series

Planetary Type Hydraulic Four Roll

8' ~ 14' Bending Lengths

13.77" ~ 26.77" Top roll diameter

3/8" ~ 3" Capacity

The R-HYBRID series are variable-geometry plate rolls, which really operates more like a press brake than a traditional plate roll, is making such extreme rolling possible. The two lower rolls are very similar to adjustable V die, and the top roll can be operated like the ram of a press brake. They are suitable for medium and thick plate bending.

See pages 36 - 41



		R-ECO	R-SMART	R-GIANT	R-HYBRID
Bending Length Range		3' - 10'	4' - 14'	6' - 14'	8' - 14'
Top Roll Diameter		2.67"-7.08"	5.51"-16.93"	18.11"-29.92"	13.77"-26.77"
Thickness Range		Up to 3/8"	Up to 1-3/4"	Up to 3 1/2"	Up to 3"
Custom Lengths and Thickness		O	O	O	O
Obtainable Production Tolerances	Fine				
	Excellent				
Part Geometries (without experienced operator)	Simple				
	Moderate				
	Complex				
Production Speed	Medium				
	High				
Controls	Digital Read-out	O	N/A	N/A	N/A
	PLC	N/A	S	S	S
	NC	N/A	O	O	O
	CNC	N/A	O	O	N/A
Software	ESA Off-line Simulator (Available on CNC models)	N/A	O	O	N/A
Frame	Cast Iron	S	N/A	N/A	N/A
	Stress Relieved Steel Construction	N/A	S	S	S
Rolls	AISI 1050 Carbon Steel Rolls	S	S	S	S
	AISI 4140 High Strength Alloy Steel Rolls	O	O	O	O
	Induction hardening	O	N/A	N/A	N/A
	Induction hardening + Polish	O	S	S	S
	Induction hardening + Ground	O	O	O	O
Rolls Drive System	Electrical Motor + Gearbox (Top - Bottom Rolls)	S	N/A	N/A	N/A
	Hydraulic Motor + Planetary Gearbox (Top Roll)	N/A	N/A	N/A	S
	Hydraulic Motor + Planetary Gearbox (Top & Bottom Rolls)	N/A	S	S	N/A
	Hydraulic Motor + Planetary Gearbox (All Rolls)	N/A	O	O	N/A
Roll Positioning System	Manual Bottom & Side Roll	S	N/A	N/A	N/A
	Motorized Side Roll	O	N/A	N/A	N/A
	Motorized Side Roll (Ø5.91" - Ø7.08")	S	N/A	N/A	N/A
	Motorized Bottom Roll	O	N/A	N/A	N/A
	Hydraulically Acted with Electronically Positioned and Synchronized Bottom / Side Rolls	N/A	S	S	S

S = Standard / O = Option / N/A = Not Applicable



		R-ECO	R-SMART	R-GIANT	R-HYBRID
Safety	Safety Wire Around the Machine and Emergency Stop Button	S	S	S	S
Lubrication Systems	Manual lubrication	S	S	S	S
	Automatic central lubrication	N/A	O	O	O
Oil Cooler / Heater	Oil Cooler	N/A	O	O	O
	Oil Heater	N/A	O	O	O
Variable Speed	Variable Speed for Roll Rotation (Std. on CNC Control)	N/A	O	O	O
Special Color	Special Color	O	O	O	O
Air Conditioning	Air Conditioning for Electrical panel	N/A	O	O	O
Hydraulic Vertical Overhead Support Systems	Preparation for vertical support system	N/A	O	O	O
	Vertical support - Hydraulic	N/A	O	O	O
	NC inclusion for vertical support control (Available on CNC control)	N/A	N/A	O	N/A
Hydraulic Side Support Systems	Preparation for side support system	N/A	O	O	O
	Side Support System (Both Side)	N/A	O	O	O
	NC inclusion for side support control (Available on CNC control)	N/A	O	O	N/A
Feeding Systems	Material Feeding Table - L=10'	N/A	O	O	O
	Material Feeding Table - Motorized - L=10'	N/A	O	O	O

BENDING CAPACITIES AND CALCULATIONS

Our machines capacities are defined for (38Ksi) yield strength plates on multi-step bending. For different yield, length and thickness plates you can use "Bending Capacity Chart"

SELECT MACHINE	R-GENIUS 10-1299
BENDING LENGTH	122"
	10' 2"
PREBENDING CAPACITY	0.375
ROLLING CAPACITY	0.625
TOP ROLL DIAMETER	12.99"

RMT Plate Roll Calculator
www.rmtus.com

PLATE WIDTH		122"		110"		98"		85"		73"		61"		49"		37"		24"	
		100% Width		90% Width		80% Width		70% Width		60% Width		50% Width		40% Width		30% Width		20% Width	
MATERIAL TYPES	Inch Diameter	Pre-Bending Thickness	Rolling Thickness	Pre-Bending Thickness	Rolling Thickness	Pre-Bending Thickness	Rolling Thickness	Pre-Bending Thickness	Rolling Thickness	Pre-Bending Thickness	Rolling Thickness	Pre-Bending Thickness	Rolling Thickness	Pre-Bending Thickness	Rolling Thickness	Pre-Bending Thickness	Rolling Thickness	Pre-Bending Thickness	Rolling Thickness
		CLASS-1 MATERIAL Max Yield Strength	14.29"	0.343"	0.505"	0.362"	0.532"	0.384"	0.565"	0.410"	0.604"	0.443"	0.652"	0.486"	0.714"	0.543"	0.798"	0.601"	0.922"
16.89"	0.384"		0.539"	0.405"	0.588"	0.429"	0.602"	0.459"	0.644"	0.495"	0.695"	0.543"	0.762"	0.601"	0.852"	0.668"	1.100"	0.735"	1.200"
19.49"	0.404"		0.580"	0.426"	0.590"	0.452"	0.626"	0.483"	0.669"	0.521"	0.723"	0.571"	0.792"	0.630"	0.886"	0.700"	1.000"	0.800"	1.200"
25.98"	0.438"		0.576"	0.441"	0.607"	0.467"	0.644"	0.500"	0.688"	0.540"	0.743"	0.591"	0.814"	0.648"	0.910"	0.718"	1.000"	0.850"	1.200"
30.00"	0.448"		0.607"	0.470"	0.640"	0.499"	0.679"	0.533"	0.726"	0.576"	0.784"	0.631"	0.858"	0.699"	0.960"	0.778"	1.000"	0.900"	1.200"
38.98"	0.462"		0.641"	0.487"	0.676"	0.516"	0.717"	0.552"	0.766"	0.596"	0.827"	0.651"	0.906"	0.718"	1.000"	0.800"	1.000"	0.900"	1.200"
CLASS-2 MATERIAL Max Yield Strength	14.29"	0.319"	0.469"	0.336"	0.494"	0.356"	0.524"	0.381"	0.560"	0.412"	0.605"	0.451"	0.665"	0.504"	0.741"	0.582"	0.856"	0.668"	1.000"
	15.59"	0.336"	0.500"	0.376"	0.527"	0.398"	0.558"	0.426"	0.598"	0.460"	0.645"	0.504"	0.707"	0.563"	0.791"	0.630"	0.913"	0.735"	1.000"
	19.49"	0.375"	0.520"	0.395"	0.548"	0.419"	0.581"	0.448"	0.622"	0.484"	0.671"	0.530"	0.735"	0.593"	0.822"	0.668"	0.949"	0.800"	1.000"
	25.98"	0.388"	0.534"	0.409"	0.563"	0.434"	0.597"	0.464"	0.639"	0.501"	0.690"	0.549"	0.756"	0.615"	0.845"	0.718"	0.976"	0.850"	1.000"
	30.00"	0.414"	0.564"	0.437"	0.594"	0.463"	0.630"	0.495"	0.674"	0.535"	0.728"	0.586"	0.797"	0.657"	0.891"	0.755"	1.000"	0.900"	1.200"
	38.98"	0.429"	0.595"	0.452"	0.627"	0.479"	0.665"	0.512"	0.711"	0.553"	0.768"	0.601"	0.841"	0.680"	0.941"	0.778"	1.000"	0.900"	1.200"
CLASS-3 MATERIAL Max Yield Strength	14.29"	0.266"	0.391"	0.280"	0.412"	0.297"	0.437"	0.318"	0.467"	0.343"	0.505"	0.376"	0.553"	0.421"	0.618"	0.486"	0.714"	0.565"	0.875"
	16.89"	0.297"	0.417"	0.313"	0.440"	0.332"	0.466"	0.355"	0.499"	0.384"	0.539"	0.420"	0.590"	0.470"	0.660"	0.543"	0.762"	0.630"	0.933"
	19.49"	0.313"	0.454"	0.330"	0.457"	0.350"	0.485"	0.374"	0.519"	0.404"	0.560"	0.442"	0.614"	0.495"	0.686"	0.571"	0.752"	0.668"	0.970"
	25.98"	0.324"	0.446"	0.341"	0.470"	0.362"	0.498"	0.387"	0.533"	0.418"	0.576"	0.458"	0.631"	0.512"	0.705"	0.591"	0.814"	0.700"	0.997"
	30.00"	0.346"	0.470"	0.364"	0.496"	0.387"	0.526"	0.413"	0.562"	0.446"	0.607"	0.489"	0.665"	0.547"	0.744"	0.628"	0.850"	0.750"	1.000"
	38.98"	0.358"	0.496"	0.377"	0.523"	0.400"	0.555"	0.427"	0.599"	0.462"	0.641"	0.506"	0.702"	0.585"	0.785"	0.668"	0.906"	0.800"	1.000"

Specifications subject to verification. Due to ongoing product development, machine specifications can change at any time.



R-ECO A / B MOTORIZED INITIAL PINCH THREE ROLLS



BENDING THIN SHEET METAL?

These initial pinch rolls are designed for small part bending with low operation cost. R-ECO rolls feature robust cast iron frames (or steel welded frame depend on size), chain and gearbox drive systems and electric motors with a magnetic break which eliminates drifting. They also offer foot pedals with forward, reverse, and emergency stop along with a safety wire and limit switch.

A very economical, reliable, and efficient choice for your small parts needs.



R-ECO C / D MOTORIZED INITIAL PINCH THREE ROLLS



R-ECO C

RMT R-ECO series initial pinch plate rolls are generally for lighter capacity applications and come in manual, motorized or hydraulic. They work by “pinching” the flat sheet between top and bottom rolls while the side (back) roll moves upward to contact and then bend the sheet. When rotation of the rollers is activated, the sheet exits at a given radius. With the sheet cut to the developed length and the bending roll properly positioned; the part is rolled into a cylindrical form, where it can then be welded at the seam to produce a cylinder. The top roll is in a fixed position; the bottom pinch roll can move up/down to pinch the material. The side roll is also adjustable by manually, motorized or hydraulically. To remove a rolled cylinder, it must be extracted from off of the top roll. Machines are generally equipped with release mechanism on the top roll to allow extraction of the cylinder. Typical methods are either a forward tilting or releasing top roll or a removable end yoke. In most applications, these machines require removal and re-insertion of the sheet in order to pre-bend both ends. They are cost effective but in contrast may be more labor intensive in a production setting.



R-ECO D



R-ECO A-B SERIES

R-ECO A Series



ø2.67"-ø2.95"

R-ECO B Series



ø3.54"-ø3.93"

R-ECO C Series



ø4.33"-ø5.51"

R-ECO D Series



ø5.91"-ø7.08"

R-ECO A-B

MOTORIZED INITIAL PINCH THREE ROLLS

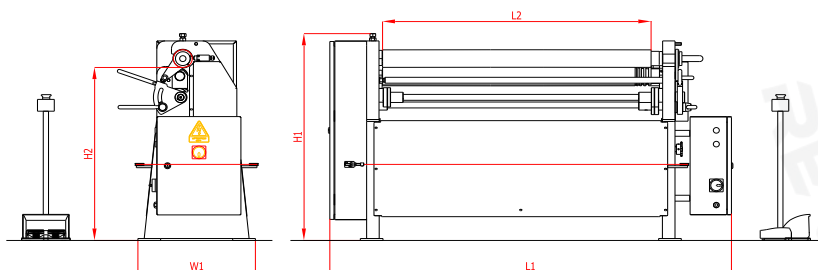

MODEL TYPE	Bending Length	Bending Capacity	Top Roll	Length	Width	Height	Working Height	Ağırlık Weight (Lbs)	Main Motor Power (HP)	Optional Back Roll Motor Power (HP)
	L2 (inch)	T (inch)	Ød (inch)	L1 (inch)	W (inch)	H1 (inch)	H2 (inch)			
R-ECO A 3-267	3' 4"	16 Ga	2.67	66	22	27	35	838	1	0.5
R-ECO A 3-295	3' 4"	14 Ga	2.95	66	22	27	35	849	1	0.5
R-ECO B 3-354	3' 4"	12 Ga	3.54	66	22	27	35	992	2	0.75
R-ECO B 3-393	3' 4"	10 Ga	3.93	66	22	27	35	1069	2	0.75
R-ECO A 4-267	4' 2"	18 Ga	2.67	75	22	27	35	981	1	0.5
R-ECO A 4-295	4' 2"	16 Ga	2.95	75	22	27	35	1003	1	0.5
R-ECO B 4-354	4' 2"	14 Ga	3.54	75	22	27	35	1168	2	0.75
R-ECO B 4-393	4' 2"	12 Ga	3.93	75	22	27	35	1268	2	0.75
R-ECO A 5-267	5'	22 Ga	2.67	86	22	27	35	1102	1	0.5
R-ECO A 5-295	5'	20 Ga	2.95	86	22	27	35	1168	1	0.5
R-ECO B 5-354	5'	16 Ga	3.54	86	22	27	35	1323	2	0.75
R-ECO B 5-393	5'	14 Ga	3.93	86	22	27	35	1455	2	0.75
R-ECO A 6-295	6' 7"	25 Ga	2.95	105	22	27	35	1290	1	0.5
R-ECO B 6-354	6' 7"	22 Ga	3.54	105	22	27	35	1499	2	0.75
R-ECO B 6-393	6' 7"	16 Ga	3.93	105	22	27	35	1653	2	0.75

The mentioned values above is only works for 38 KSI yield point material
 Different material types and plate widths ; can be calculated with RMT Roll Bending Calculator
 Conical bending capacities depends on cone angle and half value of mentioned values above.
 Weight and motor powers may increase with optional features.
 Due to ongoing product development, specifications may change at any time

Larger or Custom
Machines Available

R-ECO C SERIES

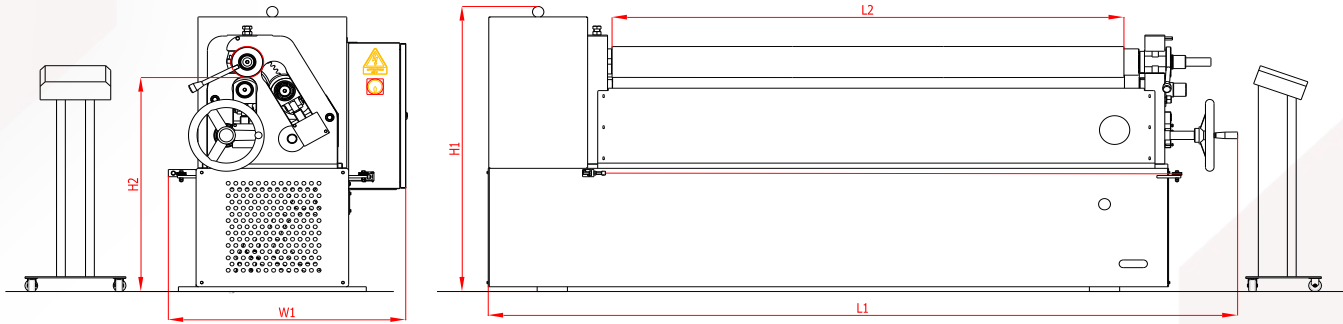

MODEL TYPE	Bending Length	Bending Capacity	Top Roll	Length	Width	Height	Working Height	Ağırlık Weight	Main Motor Power	Optional Back Roll Motor Power
	L2 (inch)	T (inch)	Ød (inch)	L1 (inch)	W (inch)	H1 (inch)	H2 (inch)	(Lbs)	(HP)	(HP)
R-ECO C 3-433	3' 4"	8 Ga	4.33	78	37	47	36	2635	3	1.5
R-ECO C 3-472	3' 4"	7 Ga	4.72	78	37	47	36	2723	3	1.5
R-ECO C 3-511	3' 4"	6 Ga	5.11	78	37	47	36	2811	3	1.5
R-ECO C 3-551	3' 4"	5 Ga	5.51	78	37	47	36	2899	3	1.5
R-ECO C 4-433	4' 2"	10 Ga	4.33	88	37	47	36	2877	3	1.5
R-ECO C 4-472	4' 2"	8 Ga	4.72	88	37	47	36	2965	3	1.5
R-ECO C 4-511	4' 2"	7 Ga	5.11	88	37	47	36	3053	3	1.5
R-ECO C 4-551	4' 2"	6 Ga	5.51	88	37	47	36	3142	3	1.5
R-ECO C 5-433	5'	12 Ga	4.33	98	37	47	36	2950	3	1.5
R-ECO C 5-472	5'	11 Ga	4.72	98	37	47	36	3038	3	1.5
R-ECO C 5-511	5'	10 Ga	5.11	98	37	47	36	3142	3	1.5
R-ECO C 5-551	5'	8 Ga	5.51	98	37	47	36	3245	3	1.5
R-ECO C 6-433	6' 7"	14 Ga	4.33	117	37	47	36	3131	3	1.5
R-ECO C 6-472	6' 7"	12 Ga	4.72	117	37	47	36	3208	3	1.5
R-ECO C 6-511	6' 7"	11 Ga	5.11	117	37	47	36	3289	3	1.5
R-ECO C 6-551	6' 7"	10 Ga	5.51	117	37	47	36	3450	3	1.5
R-ECO C 8-551	8' 3"	12 Ga	5.51	137	37	47	36	3655	3	1.5

The mentioned values above is only works for 38 KSI yield point material
 Different material types and plate widths ; can be calculated with RMT Roll Bending Calculator
 Conical bending capacities depends on cone angle and half value of mentioned values above.
 Weight and motor powers may increase with optional features.
 Due to ongoing product development, specifications may change at any time

**Larger or Custom
Machines Available**

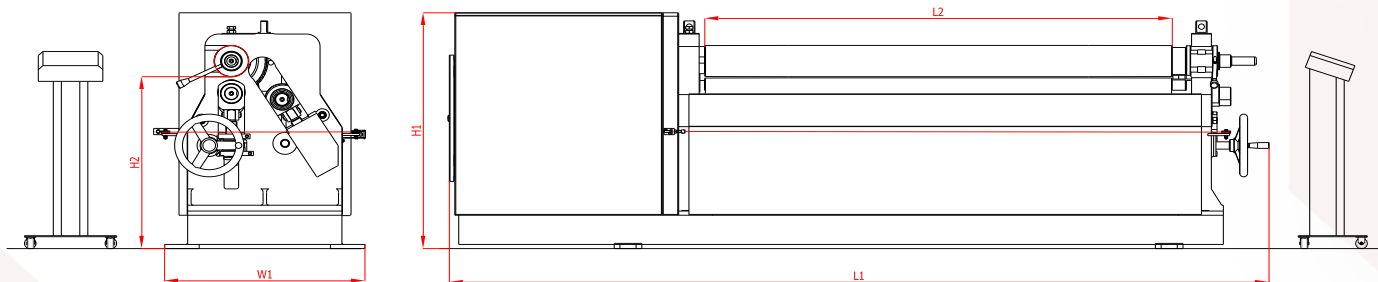

MODEL TYPE	Bending Length	Bending Capacity	Top Roll	Length	Width	Height	Working Height	Ağırlık Weight	Main Motor Power	Back Roll Motor Power
	L2 (mm)	T (mm)	Ød (mm)	L1 (mm)	W (mm)	H1 (mm)	H2 (mm)	(kg)	(kW)	(kW)
R-ECO D 3-590	3' 4"	1/4"	5.90	101	35	45	33	4784	5.5	4
R-ECO D 3-629	3' 4"	9/32"	6.29	101	35	45	33	4960	5.5	4
R-ECO D 3-669	3' 4"	5/16"	6.69	101	35	45	33	5170	5.5	4
R-ECO D 3-708	3' 4"	3/8"	7.08	101	35	45	33	5390	5.5	4
R-ECO D 4-590	4' 2"	7/32"	5.90	111	35	45	33	5071	5.5	4
R-ECO D 4-629	4' 2"	1/4"	6.29	111	35	45	33	5269	5.5	4
R-ECO D 4-669	4' 2"	9/32"	6.69	111	35	45	33	5490	5.5	4
R-ECO D 4-708	4' 2"	5/16"	7.08	111	35	45	33	5721	5.5	4
R-ECO D 5-590	5'	3/16"	5.90	121	35	45	33	4883	5.5	4
R-ECO D 5-629	5'	7/32"	6.29	121	35	45	33	5115	5.5	4
R-ECO D 5-669	5'	1/4"	6.69	121	35	45	33	5379	5.5	4
R-ECO D 5-708	5'	9/32"	7.08	121	35	45	33	5644	5.5	4
R-ECO D 6-590	6' 7"	5/32"	5.90	141	35	45	33	5445	5.5	4
R-ECO D 6-629	6' 7"	3/16"	6.29	141	35	45	33	5710	5.5	4
R-ECO D 6-669	6' 7"	7/32"	6.69	141	35	45	33	5897	5.5	4
R-ECO D 6-708	6' 7"	1/4"	7.08	141	35	45	33	6239	5.5	4
R-ECO D 8-590	8' 3"	1/8"	5.90	160	35	45	33	5952	5.5	4
R-ECO D 8-629	8' 3"	5/32"	6.29	160	35	45	33	6140	5.5	4
R-ECO D 8-669	8' 3"	3/16"	6.69	160	35	45	33	6471	5.5	4
R-ECO D 8-708	8' 3"	7/32"	7.08	160	35	45	33	6889	5.5	4
R-ECO D 10-629	10'	1/8"	6.29	180	35	45	33	8267	5.5	4
R-ECO D 10-708	10'	5/32"	7.08	180	35	45	33	9370	5.5	4

The mentioned values above is only works for 38 KSI yield point material
 Different material types and plate widths ; can be calculated with RMT Roll Bending Calculator
 Conical bending capacities depends on cone angle and half value of mentioned values above.
 Weight and motor powers may increase with optional features.
 Due to ongoing product development, specifications may change at any time

**Larger or Custom
Machines Available**

STANDARD (R-ECO A Series)

- Top and bottom rolls are powered by a helical type gearbox and AC motor
- AISI 1050 Quality Certificated steel rolls with high tensile strength
- Solid steel frame.
- Mechanical manual mechanical drop-end.
- Foot pedal.
- Conical bending device
- Manual lubrication points
- Precision bending with brake motor
- Wire grooves at the end of the rolls (.157"/.275"/.354")

OPTIONAL (R-ECO A Series)

- Digital Read-Out for rear (back) roll
- Induction hardened and polished rolls

STANDARD (R-ECO B Series)

- Top and bottom rolls are powered by a helical type gearbox and AC motor
- AISI 1050 Quality Certificated steel rolls with high tensile strength
- Solid steel frame.
- Mechanical manual mechanical drop-end.
- Foot pedal.
- Conical bending device
- Manual lubrication points
- Precision bending with brake motor
- Wire grooves at the end of the rolls (.157"/.275"/.354")

OPTIONAL (R-ECO B Series)

- Digital Read-Out for rear (back) roll
- Induction hardened and polished rolls
- Motorized adjustment of back roll

STANDARD (R-ECO C Series)

- Top and bottom rolls are powered by a helical type gearbox and AC motor
- AISI 1050 Quality Certificated steel rolls with high tensile strength
- Solid steel frame.
- Mechanical manual mechanical drop-end.
- Foot pedal.
- Conical bending device
- Manual lubrication points
- Precision bending with brake motor
- Wire grooves at the end of the rolls (.157"/.275"/.354"/.511")

OPTIONAL (R-ECO C Series)

- Digital Read-Out for rear (back) roll
- Induction hardened and polished rolls
- Motorized adjustment of back roll
- Extended roll shafts for profile and pipe bending operations

STANDARD (R-ECO D Series)

- Top and bottom rolls are powered by a helical type gearbox and AC motor
- AISI 1050 Quality Certificated steel rolls with high tensile strength
- Solid steel frame.
- Mechanical manual mechanical drop-end.
- Mobile control panel
- Conical bending device
- Manual lubrication points
- Top roll support system
- Precision bending with a motor brake
- Motorized adjustment of back roll

OPTIONAL (R-ECO D Series)

- Digital Read-Out for rear (back) roll
- Induction hardened and polished rolls
- Extended roll shafts for profile and pipe bending operations
- Profile and section bending rolls set
- Motorized bottom roll (pinching)
- Segmented plastic rolls for composite bending



BENEFIT OF RMT 4 ROLL PLATE BENDING MACHINES

- The fastest and most accurate bends are made by four roll machines. The plate is held securely in place between the top and bottom rolls while the side rolls move vertically to create the bend.
- The bottom roll moves up to hold the plate edge securely against the top roll while the side roll is raised to form an accurate pre-bend, minimizing the flat zone on the plate edge. Pre-bending on a double pinch three roll machine requires that plates be tilted down as they are being fed. In contrast, plates are loaded horizontally at the feed level for pre-bending on a four roll machine, which allows the use of horizontal motorized roller tables to help feed the plate.
- Plate feeding can take place on either side of a four roll machine. If fed from only one side, they can even be placed up against a wall to save floor space.
- The side rolls are positioned to the right and left of the bottom roll and are on their own axes. The independent axis of each roll helps make a perfect bend. The "back" side roll (at the far side of the feeding point) also functions as a back gauge to square the plate for proper alignment (see figure 1). This eliminates the need for someone to assist the operator.
- The plate is kept square without slipping during both pre-bending and rolling because of the constant secure clamping of the top and bottom rolls.
- Four roll machines do not require the operator to remove, flip, and then try to square the plate a second time after pre-bending, as is the case with three roll initial pinch (IP) machines. Keeping the material in the machine makes four rolls 50% more efficient than three roll IP machines, and allows a cylinder to be rolled to the required diameter immediately following pre-bending.
- Bending the back edge takes place after the cylinder is rolled, for a one direction, single pass operation.
- Cone rolling is easier on a four roll machine. The side rolls can be tilted to establish the cone angle and the bottom roll can also be tilted to clamp and drive the plate.
- Four roll machines are the only type of plate rolls that can effectively make use of NC and CNC controls because of the constant clamping and driving of the material during all steps of rolling. Bending difficult shapes like polycentric or elliptic work pieces can be easily done with CNC four roll machines.

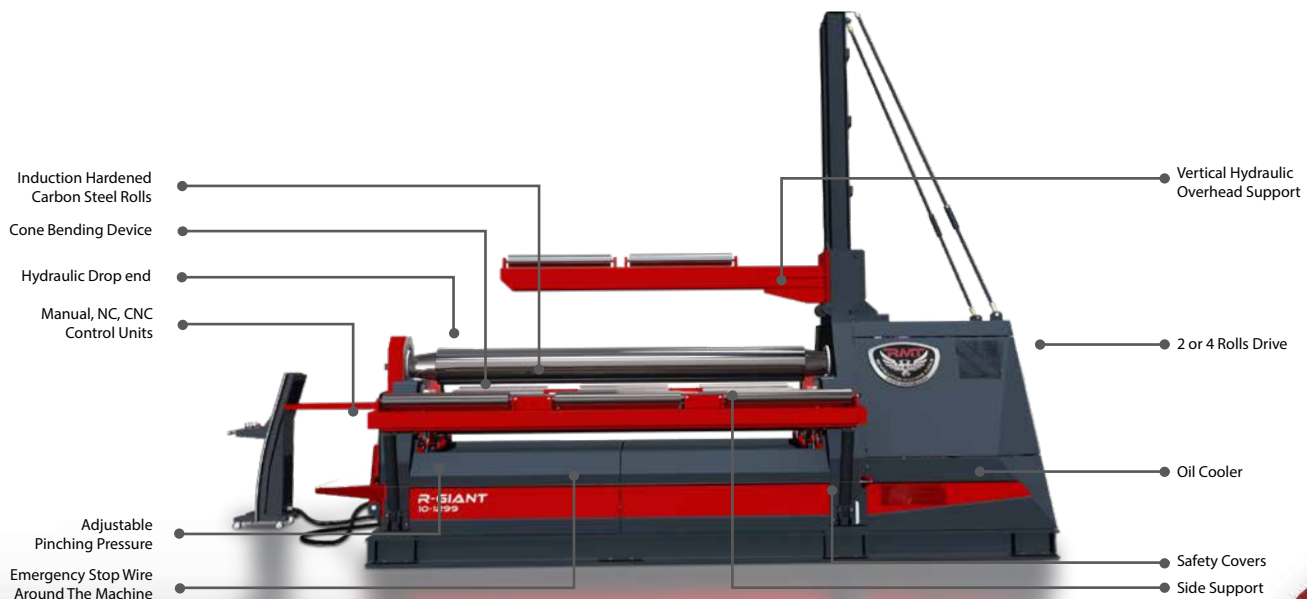
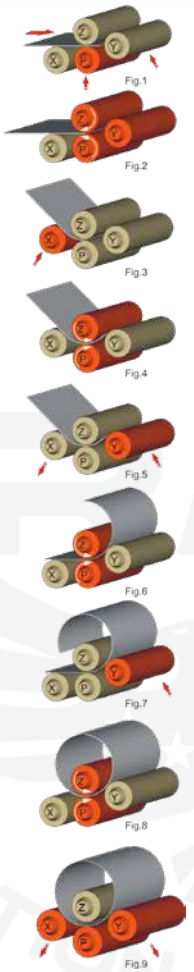



BENEFIT OF RMT 4 ROLL PLATE BENDING MACHINES

Accuracy

RMT machines are designed with state-of-the-art technologies that provide unparalleled accuracy and precision. This is the result of our world-class Research and Development department that has been constantly perfecting our machines for decades, allowing us to consistently outperform competitor machines year after year.

Reliability

RMT machines are designed from the ground up by our expert engineers with only one goal: to build the best machines imaginable. By combining our unique machine designs with the highest quality materials available, we realized our goal and invented some of the most reliable and durable machines in the world!

Efficiency

We understand the importance of a disruption-free production to your success, and have done everything in our power to maximize the efficiency of our RMT machines. We have meticulously identified and removed every hindrance to efficiency in our machines, providing you with the most seamless manufacturing experience imaginable.

Safety

Safe operation of heavy machinery for the operator and any bystanders is paramount to any successful enterprise, which is why RMT machines have a multitude of safety features in place, oftentimes exceeding industry standards. We have even implemented our own innovative safety features when existing ones were inadequate or non-existent.

Flexibility

RMT is committed to the universalization of machinery and machine tools, because it not only prevents our customers from having to reinvest in new tooling and accessories, but allows for remarkable flexibility. The enhanced flexibility and longevity of our machines provides for a significantly broader range of applications, maximizing value.

Customizability

RMT machines are highly customizable and because RMT manufactures our own designs, we have the capability to tailor-make machines to fit our customers' needs. Put us to the test and see what we can come up with to help you complete difficult or otherwise impossible jobs. Regardless of the project, RMT can help realize it!





ROLLS

For R-SMART and R-GIANT



The most important elements of a plate roll machine are the rolls themselves. Most machines in the market have smaller diameter, weak rolls that deform during the pre-bending process and create a flat spot on the plate edge.

RMT designed the rolls with larger diameter and uses high tensile forged steel rolls that are machined by high precision CNC lathes. The working surfaces of the rolls are CNC induction hardened to HRC 54-58 (5-6 mm depth) with hardness tests performed at varying points on the rolls. The smallest bending diameter of 1.1 x top roll diameter is easily achieved.

The rolls are machined with a crown to compensate for roll deflection during the pre-bending process. Custom crown machined rolls for different materials or thickness can be applied free of charge when ordering.

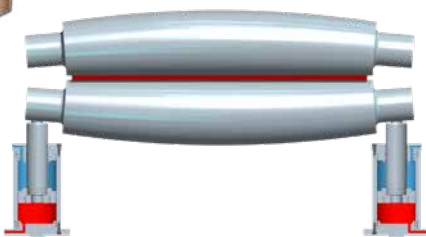

Bending thickness is compatible with roll crowning

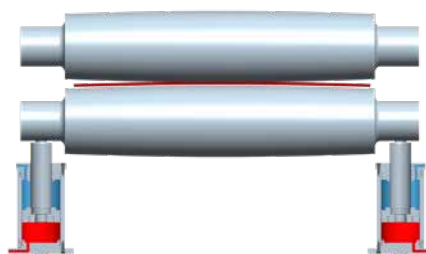
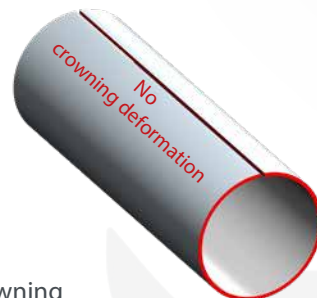

Bending thickness is thinner than roll crowning

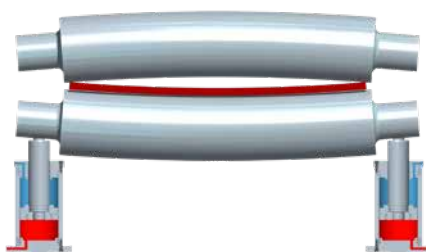

Bending thickness is thicker than roll crowning

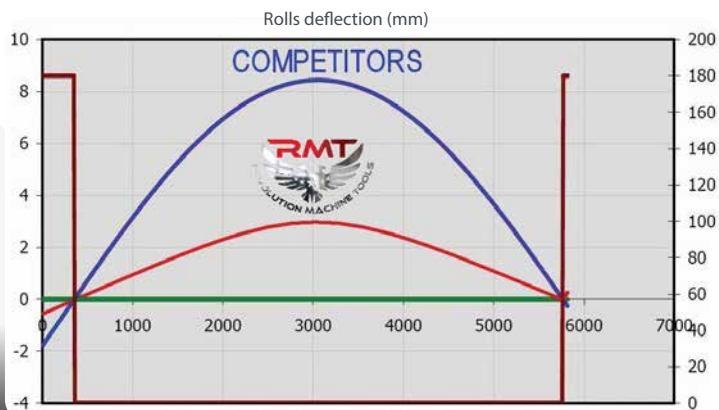

HYDRAULIC DROP END

Standard on R-SMART and R-GIANT



Hydraulic drop ends on R-SMART 4 Rolls - allow for easy removal of formed pieces. Cone snubber is a standard feature that is placed on a top roll bearing allowing easy rotation of snubber (so it can not interfere with extraction).

On our R-GIANT 4 Rolls - the heavy duty roller snubber system is mounted to the main frame of the machine. The top roll is hydraulically tilted up to allow for easy removal of formed parts.

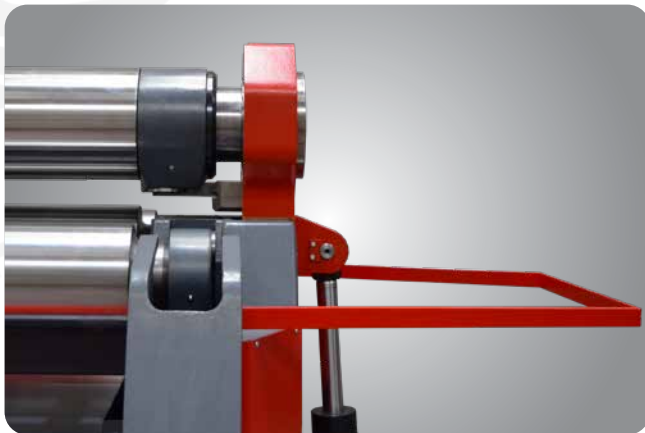

R-SMART Series: Fixed top roll

R-GIANT Series: Tilttable top roll



CONE BENDING

Standard on R-SMART and R-GIANT

Through superior construction, a massive body and the ability to angle the bottom and side rolls, you can easily bend wide angle and small diameter conical parts.

While most machines on the market can conically bend 3 times the diameter of the top roll, RMT 4 roll plate bending machines can conically bend 1.5 times the top roll diameter (or tighter).

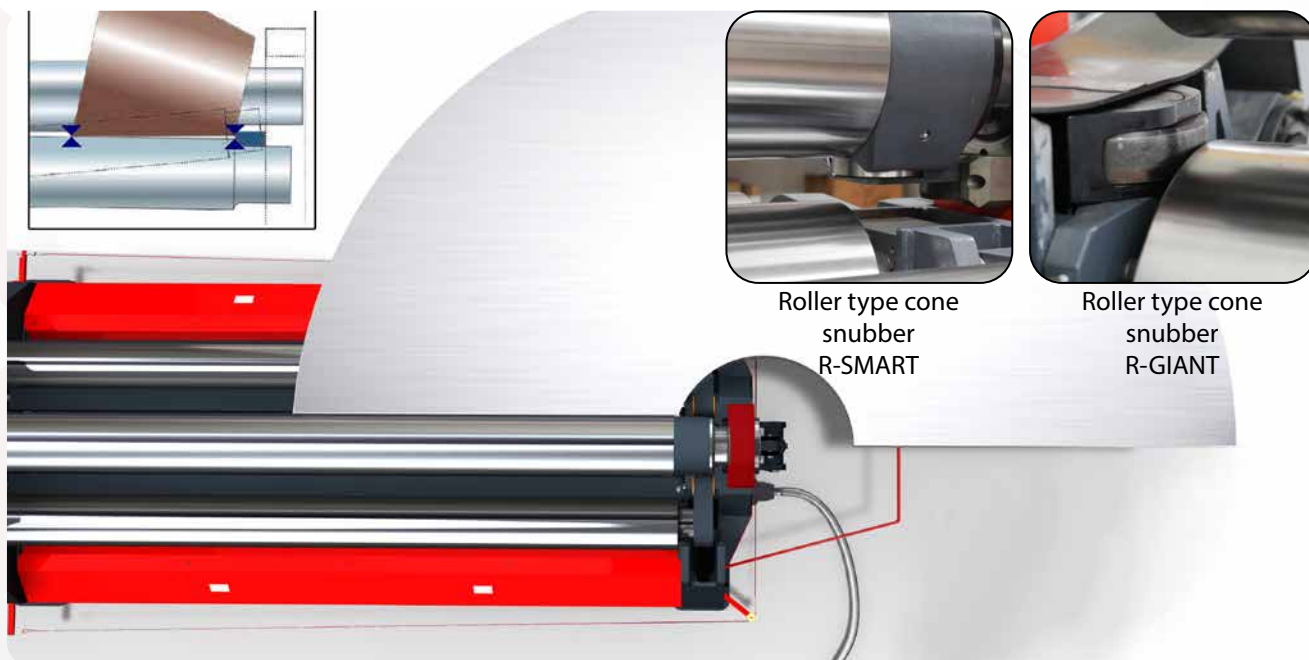

SIDE AND OVERHEAD SUPPORT SYSTEM

Optional on R-SMART and R-GIANT



Optional hydraulic side or overhead supports help prevent distortion of the cylinder in large shaped bends. Side supports have hydraulic double cylinders which are produced with heavy-duty steel construction. The vertical support capacity can be manufactured to different tonnage and height requirements.



CUSTOM APPLICATION SHEET SUPPORT SYSTEMS



Cartesian type overhead support

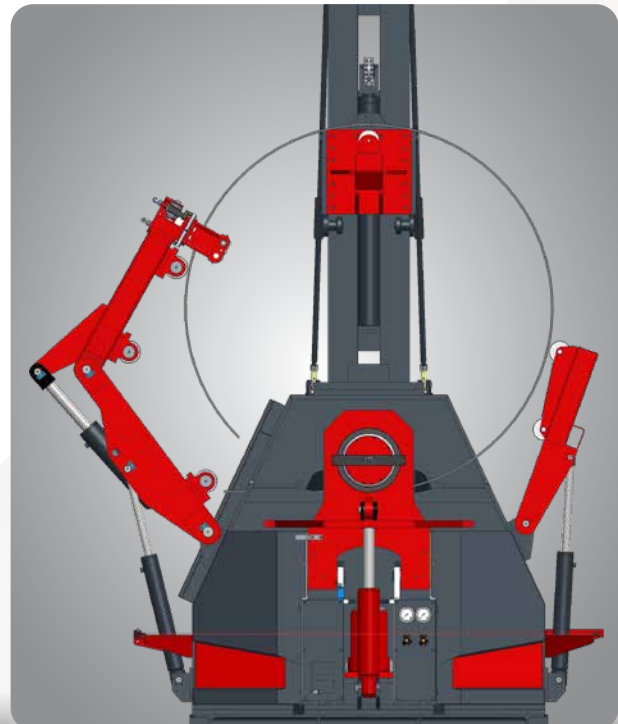

Dual knuckle side support with edge alignment clamps



HYDRAULIC & ELECTRIC SYSTEM

Standard on R-SMART and R-GIANT

Our R-SMART and R-GIANT machines movements are actuated by hydraulic components. The precision of all axes are acquired by world leader Duplomatic valves' high speed response ability along with pressure safety valves used against peak pressures and overload, provides protection for motors and other components. The electrical system is designed to be compatible with CE safety regulations. The system consists of well known electrical components such as Siemens, Schneider, Phoenix and Opkon.



HIGH TORQUE DRIVE SYSTEM

With its high torque, RMT plate rolls can bend the sheet with fewer steps. Rolls are triggered by independent high torque AC or hydro motors and planetary gearboxes. A trigger system is positioned on the same axis as the roll, which transfers the torque to the sheet without losing torque strength. Strong Electric / Hydraulic Brakes : Especially during the pre-bend, our system does not allow the sheet to slip back and create safety problems.



OPTIONAL GAS SHOCK ABSORBER

When the sheets are bent, welding process begins on machine. In particular, the combination of tension that occurs during welding of thin sheet point inward pulling thus causes the deterioration of cylindrical form. So, expressed as re-rolling must be done after the welding operation in calibration. However, often the welding would be thicker than the sheet thickness and shall not be cleaned. On standard machines welding cannot pass through between top and bottom rolls. If clamping pressure too much and welding area too thick, rolls have chances of getting damaging dents to roll face. RMT has developed gas shock absorber. Each end of the lower roller system on the hydraulic accumulators we connected to the rollers and bottom roller when the desired deflection controlling valves consists of. Thus, when welding passing through the roller, lower roller moves up and down automatically.



PLC CONTROL SYSTEM

Standard on R-SMART and R-GIANT



The PLC control system ensures the machine's bottom and side rollers' synchronous operation. This process is provided via the PLC with 6 Axis control and touch screen operator panel. In addition, prior experience, the circular bending with the facility for bending up to 5 steps of the program, is ease of use and saves time.



PLC Control Unit

Dedicated scratch-proof, oil-proof, acid-resistant IP65 sealed touch panel

PLC

- Panasonic 32 I/O

Memory

- 5 Mbyte

Display

- Monochrome LCD 3" ekran

- Resolution

- 128 (W) x 64 (H)

- 3 colors led back light (green,red, orange)

- Communication port 1 RS232C Seri Port

- Temperature -20 / 60°C

Software

- Manual working mod

- Standard 6 Axes (X1,X2,Y1,Y2,P,P1)

- 3 colors display for machine situation

- Conic and parallelism control

- 5 set point programming

- Contrast adjusting

- Turkish, English, German, French, Spanish, Polish,

- Hungarian, and Croation languages

- Alarm list

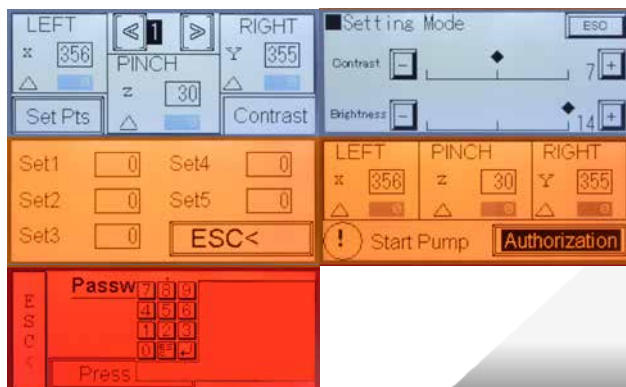



OPTIONAL NC (SIMPLE CNC)



NC control system, in addition to the PLC control system, has the property to work manual, teach-in, and automatic modes of operation. In manual mode, the use of all functions are provided by the operator. In teaching mode for the operator to twist all the steps are recorded respectively. In automatic mode all recorded movements are repeated respectively by the machine.

The NC control unit is also capable of calculating bending steps one by one. NC control system has the capacity to save 2500 programs consisting of max 100-steps.

1- Manual mode

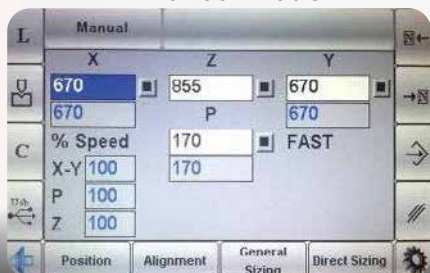

2- Teach-in programming

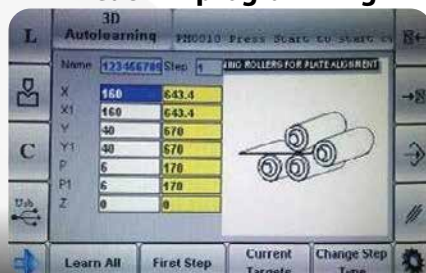

3- Select material, enter thickness

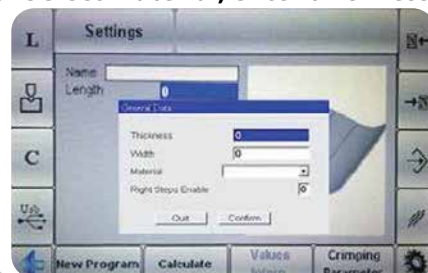

NC CONTROL UNIT (S530)



NC Control Unit (S530)

- Dedicated scratch-proof, oil-proof, acid-resistant
- IP65 sealed membrane push buttons with 51 keys
- Fiberoptic communication lines

PLC

Esa/Gv

CPU

AMD Geode™ LX800 500MHz

Memory

256 Mbyte DRAM for CPU

1 Mbyte SRAM for parameters

Communication ports

- 1 CAN interface
- 1 RS232C Serial Port
- 2 USB Port, 1 VGA Out

Temperature

--25 / 70°C

Software specifications

- Manual, teach-in and automatic working modes
- Standard 7 Axes (X1, X2, Y1, Y2, P, P1, Z)
- Conic and parallelism control
- Adjustable speeds
- 100 step, 2500 program memory
- User friendly program editor
- USB port for programs backup
- Part pcs programming
- Working hours counter
- mm / inch system
- Automatic turn off programming
- Turkish, English, German, French, Spanish, Italian, Russian, Polish languages
- Alarm list



4- Enter radius and arc angle/length



5- Program calculated

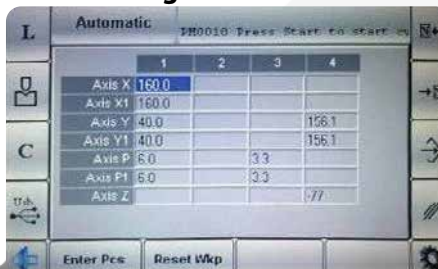

6- Save program

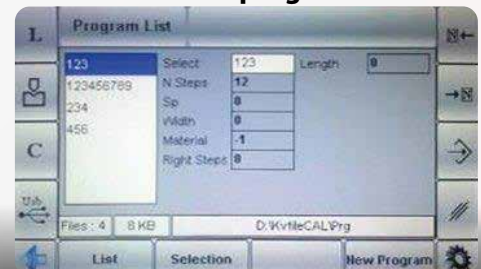



CNC UNIT (S550)

For R-SMART and R-GIANT



- Standard 7 Axes (X1,X2,Y1,Y2,P1,P2,Z)
- Standard 32 inputs and 32 outputs
- 15" TFT XGA color touch display with anti-glare screen
- Dedicated scratch-proof, oil-proof IP65 keyboard with 28 keys
- 2.5" Hard disk drive 20GBytes or more
- Hand wheel for adjustable turning speed
- Industrial keyboard (USB)

Technology

- CPU PC: Intel Atom N270 1,6Ghz with 1Gb of RAM
- CPU CNC: AMD Geode ETX-LX800 500 MHz, with 128Mb

Communication ports

- 1 serial ports RS-232, 3 USB ports, 2 Ethernet port on the PC
- 2 serial ports RS-232, 2 USB, 1 Ethernet port, 1 Can Open Port on CNC
- Fiber optic interface
- Local area network

User memory

- Hard disk for more than 2.000.000 part programs

Software specifications

- Windows® 10 operating system
- Manual, teach-in and automatic working modes
- Conic and parallelism control
- Interactive 2D graphic editor for work-pieces and tools data entry
- 2D graphic display of machine rolls
- 2D automatic identification of the best bending sequence
- Programming of the axes positions in tabular mode with automatic syntactical checks
- Automatic calculation of the X,R,P and Z axes positions for cylindrical, polycentric, oval, oval parallel sides, rectangular, arc bending shapes
- Material database of common steel plates
- X-Z / Y-Z (Side Roll & Rotation) axes interpolation capability
- Bending and working hours counter
- Metric and imperial units
- Off-line programming
- English, German, French, Spanish, Italian, Russian, Polish, languages
- Alarm messages



7- Make corrections

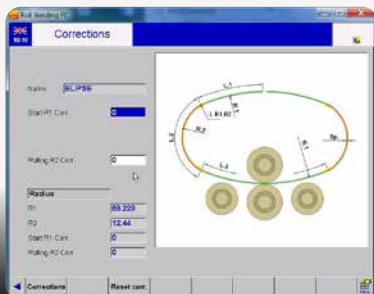

8- Insert corrections to database

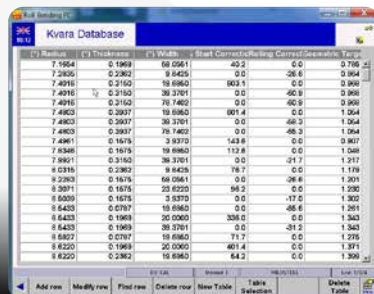

9- Save program

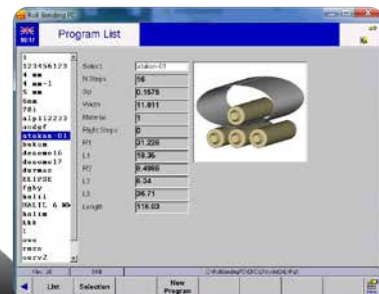

OPTIONAL CNC

For R-SMART and R-GIANT



The CNC unit, with its graphical control system allows the bending to be done step by step or by automatically calculating the bending steps. Due to changes in the structure of the material, corrections must be entered for pre-bending and bending steps after the first bended plate to get the desired bending form. Correction coefficients can be recorded to software for using them in similar characteristic material bending operations. With the CNC control you can easily bend parts into shapes such as: cylindrical, polycentric, elliptical, oval, parallel side, rectangular, and arc. CNC unit has interpolation capability due to proportional valves. The CNC unit can store more than 2,000,000 programs. The easy to use editor page also allows for simple editing of any saved programs. The unit also comes with a USB port allowing for easy up or downloading of your programs. You can also connect the control directly with your computer using an Ethernet cable. This also allows our service team to remote in if diagnosis is ever necessary. This also allows our service team to remotely access the machine if diagnosis is ever necessary. Lubrication system (offered as an option) operating times can be set at the control unit. Plate feeder, vertical and side sup-ports (offered as an option) can be included as NC functions (teachable) into control unit. So supports can be programmed in teach-in mode and provided automatically during bending.

1- Manual mode

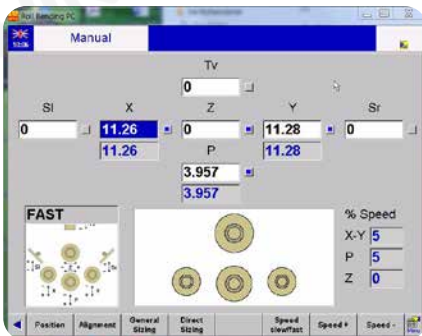

2- Select shape

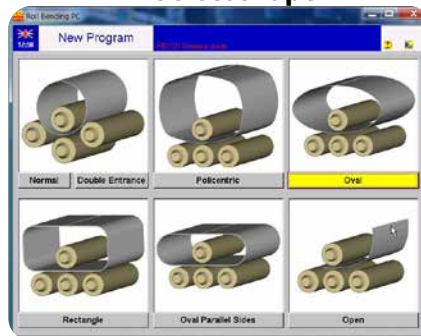

3- Select material, enter thickness

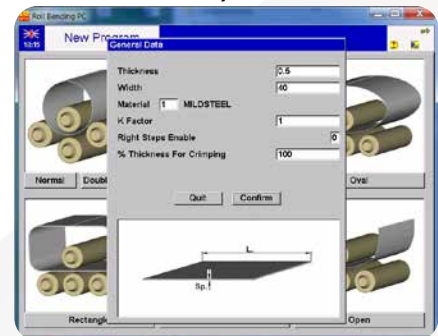

4- Enter part dimensions

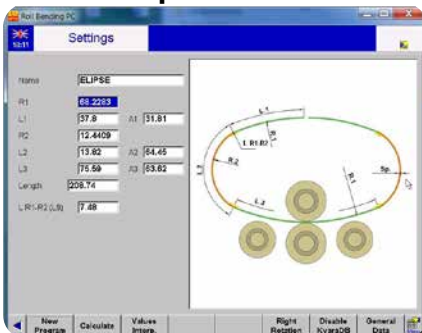

5- Program calculated



6- Start bending

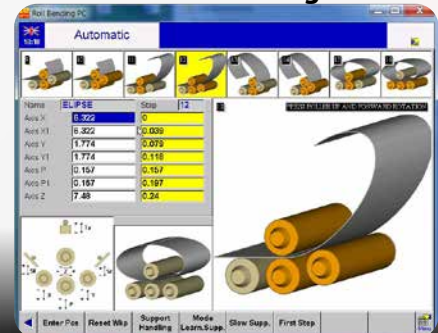



R-SMART HYDRAULIC FOUR ROLL BENDING MACHINE

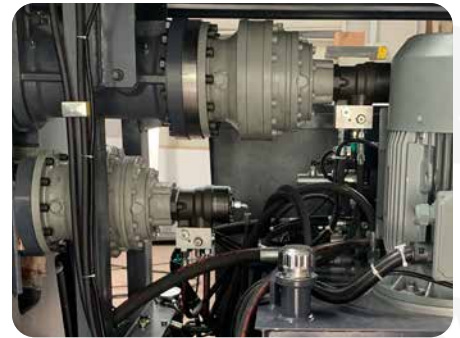

R-SMART - Planetary gearboxes

WORKHORSE

R-SMART machines have robust frames built with high quality steel construction and are fully hydraulic. Top and bottom roll are powered by hydraulic motor, gearbox and cardan drive. This is an ideal machine for shops that need an easy machine to operate using a 4 roll design, and working with material ranging from 24 gauge to 5/8". These machines come standard with conical bending for making cone shaped parts and hydraulic bottom and side roll adjustments. The R-SMART machine is available from 3'-13' lengths making it very flexible for a wide range of applications, so you get the right machine for your needs... Not a one size fits all approach.



OPTIONAL CONICAL ROLLS

Optional on R-SMART and R-GIANT



OPTIONAL PLASTIC / METAL COLLARS

We can build a machine to suit your particular requirements - (Collars can be a nice option if you are planning on forming composite panels & column covers with inside/up flange).

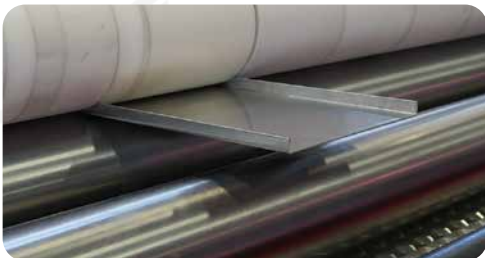



R-SMART

R-SMART HYDRAULIC PLANETARY TYPE FOUR ROLL BENDING MACHINE

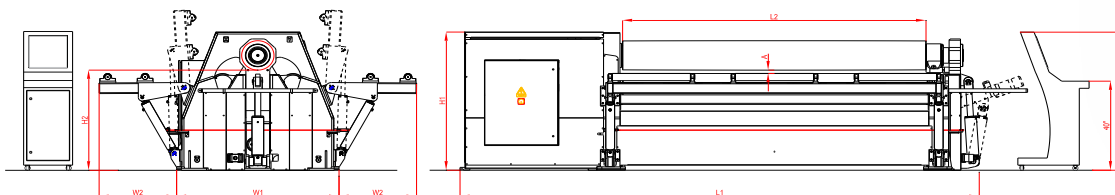

MODEL	Bending Length				Min. Inl. Dia Ø Dmin			Top Roll	Bottom Roll	Side Rolls	Max. Pass Through	Length	Width	Height	Working Height	Width of Side Support	Weight	Motor Power	Min. Additional Top roll diameter	Hydraulic Tank Capacity
	L2 (inch)	t (inch)	T (inch)	T (inch)	Ødx1,5	Ødx3	Ødx5													
R-SMART 4-551	4' 2"	5/32"	3/16"	1/4"	5.51	5.51	5.12	1/2"	123	39	45	35	22	5,357	5.5	5.51	24			
R-SMART 4-591	4' 2"	3/16"	1/4"	5/16"	5.91	5.91	5.12	1/2"	123	39	45	35	22	5,490	7.5	5.51	24			
R-SMART 4-669	4' 2"	1/4"	5/16"	11/32"	6.69	6.69	5.51	5/16"	123	39	45	35	22	5,864	7.5	5.51	24			
R-SMART 5-551	5' 1"	1/8"	5/32"	3/16"	5.51	5.51	5.12	1/2"	123	39	45	35	22	5,357	5.5	5.51	24			
R-SMART 5-591	5' 1"	5/32"	3/16"	1/4"	5.91	5.91	5.12	1/2"	123	39	45	35	22	5,490	7.5	5.51	24			
R-SMART 5-669	5' 1"	3/16"	1/4"	5/16"	6.69	6.69	5.51	5/16"	123	39	45	35	22	5,864	7.5	5.51	24			
R-SMART 6-551	6' 8"	5/64"	1/8"	5/32"	5.51	5.51	5.12	1/2"	142	39	45	35	22	5,732	4	5.51	24			
R-SMART 6-591	6' 8"	1/8"	5/32"	3/16"	5.91	5.91	5.12	1/2"	142	39	45	35	22	5,930	5.5	5.51	24			
R-SMART 6-669	6' 8"	5/32"	1/4"	9/32"	6.69	6.69	5.51	5/16"	142	39	45	35	22	6,437	7.5	5.51	24			
R-SMART 6-787	6' 8"	1/4"	5/16"	3/8"	7.87	7.87	7.48	1-3/16"	151	46	47	34	27	9,568	10	7.87	42			
R-SMART 6-827	6' 8"	5/16"	3/8"	1/2"	8.27	7.48	7.09	1-3/16"	151	46	47	33	27	9,370	15	7.87	42			
R-SMART 6-906	6' 8"	3/8"	1/2"	5/8"	9.06	8.27	7.48	1-3/16"	151	46	47	33	27	10,075	15	7.87	42			
R-SMART 6-1063	6' 8"	1/2"	5/8"	11/16"	10.63	9.84	8.66	2"	168	66	63	46	32	17,637	20	10.63	105			
R-SMART 6-1181	6' 8"	5/8"	3/4"	7/8"	11.81	10.63	8.66	2"	168	66	63	45	32	18,739	25	10.63	105			
R-SMART 6-1299	6' 8"	3/4"	1"	1-1/8"	12.99	11.81	9.45	2"	168	66	63	45	32	20,283	30	10.63	105			
R-SMART 6-1417	6' 8"	1"	1-3/16"	1-5/16"	14.17	12.99	10.63	2-3/8"	178	82	81	60	42	30,754	40	14.17	158			
R-SMART 6-1575	6' 8"	1-3/16"	1-3/8"	1-1/2"	15.75	14.57	11.42	2-1/2"	178	82	81	59	42	33,731	50	14.17	158			
R-SMART 6-1693	6' 8"	1-3/8"	1-9/16"	1-3/4"	16.93	15.75	12.60	2-3/4"	178	82	81	59	42	36,112	60	14.17	158			
R-SMART 8-787	8' 4"	5/32"	1/4"	1/4"	7.87	7.87	7.48	1-3/16"	171	46	47	34	27	10,957	10	7.87	42			
R-SMART 8-827	8' 4"	1/4"	5/16"	3/8"	8.27	7.48	7.09	1-3/16"	171	46	47	33	27	10,692	15	7.87	42			
R-SMART 8-906	8' 4"	5/16"	3/8"	1/2"	9.06	8.27	7.48	1-3/16"	171	46	47	33	27	11,574	15	7.87	42			
R-SMART 8-1063	8' 4"	3/8"	1/2"	5/8"	10.63	9.84	8.66	2"	188	66	63	46	32	19,489	20	10.63	105			
R-SMART 8-1181	8' 4"	1/2"	5/8"	11/16"	11.81	10.63	8.66	2"	188	66	63	45	32	21,164	25	10.63	105			
R-SMART 8-1299	8' 4"	5/8"	3/4"	7/8"	12.99	11.81	9.45	2"	188	66	63	45	32	23,149	30	10.63	105			
R-SMART 8-1417	8' 4"	3/4"	1"	1-1/8"	14.17	12.99	10.63	2-3/8"	198	82	81	60	42	33,400	30	14.17	158			
R-SMART 8-1575	8' 4"	1"	1-3/16"	1-5/16"	15.75	14.57	11.42	2-1/2"	198	82	81	59	42	36,200	40	14.17	158			
R-SMART 8-1693	8' 4"	1-3/16"	1-3/8"	1-1/2"	16.93	15.75	12.60	2-3/4"	198	82	81	59	42	39,132	50	14.17	158			
R-SMART 10-827	10' 2"	5/32"	1/4"	1/4"	8.27	7.48	7.09	1-3/16"	193	46	47	33	27	11,464	11	7.87	42			
R-SMART 10-906	10' 2"	1/4"	5/16"	3/8"	9.06	8.27	7.48	1-3/16"	193	46	47	33	27	12,767	15	7.87	42			
R-SMART 10-1063	10' 2"	5/16"	3/8"	1/2"	10.63	9.84	8.66	2"	210	66	63	46	32	21,385	15	10.63	105			
R-SMART 10-1181	10' 2"	3/8"	1/2"	5/8"	11.81	10.63	8.66	2"	210	66	63	45	32	23,369	20	10.63	105			
R-SMART 10-1299	10' 2"	1/2"	5/8"	11/16"	12.99	11.81	9.45	2"	210	66	63	45	32	25,574	25	10.63	105			
R-SMART 10-1417	10' 2"	5/8"	3/4"	7/8"	14.17	12.99	10.63	2-3/8"	219	82	81	60	42	36,707	30	14.17	158			
R-SMART 10-1575	10' 2"	3/4"	1"	1-1/8"	15.75	14.57	11.42	2-1/2"	219	82	81	59	42	40,345	40	14.17	158			
R-SMART 10-1693	10' 2"	1"	1-3/16"	1-5/16"	16.93	15.75	12.60	2-3/4"	219	82	81	59	42	45,195	50	14.17	158			
R-SMART 12-965	12' 1"	5/32"	1/4"	1/4"	9.65	9.06	7.48	5/16"	225	47	52	40	27	18,298	15	7.87	42			
R-SMART 12-1063	12' 1"	1/4"	5/16"	3/8"	10.63	9.84	8.66	2"	249	66	63	46	32	25,133	15	10.63	105			
R-SMART 12-1181	12' 1"	5/16"	3/8"	1/2"	11.81	10.63	8.66	2"	249	66	63	45	32	27,999	20	10.63	105			
R-SMART 12-1299	12' 1"	3/8"	1/2"	5/8"	12.99	11.81	9.45	2"	249	66	63	45	32	31,085	20	10.63	105			
R-SMART 12-1417	12' 1"	1/2"	5/8"	11/16"	14.17	12.99	10.63	2-3/8"	259	82	81	60	42	42,659	25	14.17	158			
R-SMART 12-1575	12' 1"	5/8"	3/4"	7/8"	15.75	14.57	11.42	2-1/2"	259	82	81	59	42	46,958	30	14.17	158			
R-SMART 12-1693	12' 1"	11/16"	7/8"	1"	16.93	15.75	13.39	2-3/4"	259	82	81	59	42	52,492	40	14.17	158			
R-SMART 14-965	14' 1"	1/8"	3/16"	7/32"	9.65	9.06	7.48	5/16"	225	47	52	40	27	18,298	15	7.87	42			
R-SMART 14-1063	14' 1"	5/32"	1/4"	1/4"	10.63	9.84	8.66	2"	249	66	63	46	32	25,133	15	10.63	105			
R-SMART 14-1181	14' 1"	1/4"	5/16"	3/8"	11.81	10.63	8.66	2"	249	66	63	45	32	27,999	20	10.63	105			
R-SMART 14-1299	14' 1"	5/16"	3/8"	1/2"	12.99	11.81	9.45	2"	249	66	63	45	32	31,085	20	10.63	105			
R-SMART 14-1417	14' 1"	3/8"	1/2"	5/8"	14.17	12.99	10.63	2-3/8"	259	82	81	60	42	42,659	25	14.17	158			
R-SMART 14-1575	14' 1"	1/2"	5/8"	11/16"	15.75	14.57	11.42	2-1/2"	259	82	81	59	42	46,958	30	14.17	158			
R-SMART 14-1693	14' 1"	5/8"	3/4"	7/8"	16.93	15.75	13.39	2-3/4"	259	82	81	59	42	52,492	40	14.17	158			

The mentioned values above is only works for 38 KSI yield point material
 Different material types and plate widths ; can be calculated with RMT Roll Bending Calculator
 Convex bending capacities depends on cone angle and half value of mentioned values above.
 Weight and motor powers may increase with optional features.
 Due to ongoing product development, specifications may change at any time

Larger or Custom
Machines Available

R-SMART



STANDARD

- Planetary type side roll movement.
- PLC Electronic balancing system
- Cone bending
- Induction hardened rolls (HRc 56±4)
- Polished rolls
- Single speed control of all axis
- Dual speed control of all axis (NC machines)
- Variable speed control of all axis (CNC machines)
- Machine body constructed of stress-relieved
- Highly durable carbon steel rolls machined by CNC Lathes with optimal crown (special crown upon request)
- Rolls seated in spherical bearings and bronze bushings
- Hydraulic bracket (drop end) with easy pull out system
- Top and bottom rolls driven with hydraulic motor and planetary gear box
- Automatic rolls peripheral speed compensation (optimum distribution of torque)
- Adjustable hydraulic pressure on bottom roll (crowning compensation)
- Emergency stop wire around the machine
- Electrical and hydraulic protection against overloads
- World standard electrical and hydraulic components
- Mobile control panel
- Manual lubrication
- Welding possibility on the machine

OPTIONAL

- NC Unit (Simple CNC)
- CNC Control Unit with color graphical control
- AISI 4140 High strength alloy steel rolls
- Four rolls drive
- Wired or wireless remote control
- Oil cooler
- Oil heater
- Side support system (both sides)
- Vertical hydraulic overhead support system 4, 6, 8 TON (10' - 14' - 16' - 20' tall)
- Preparation for side or vertical support system
- NC inclusion for vertical support control (Available on CNC control)
- NC inclusion for side support control (Available on CNC control)
- Plate alignment unit
- Automation system
- Changeable top roll for smaller diameter
- Special roll crowning
- Special plate support systems
- Automatic central lubrication
- Material feeding table (Idle or motorized)



R-GIANT RECTILINEAR TYPE HYDRAULIC FOUR ROLLS



R-GIANT - Planetary gearboxes

MASS PRODUCTION?

The foundation of all RMT R-GIANT Plate Rolls is a box type frame made from mill-certified, high-yield steel. As a result, RMT R-GIANT Plate Rolls perform accurately and reliably year after year.

We're so confident in our frames that we offer a 10-year warranty with our standard machines.

Hydraulic cylinders located on either side of the frames provide roll positioning. The cylinders are synchronized to provide smooth motion resulting in precise roll positions to accuracies within .004".



R-GIANT RECTILINEAR TYPE HYDRAULIC FOUR ROLLS



Hydraulic drop ends on RMT Plate Rolls allow for easy removal of formed pieces. Also the top roll is hydraulically tilted up to allow for easy removal of formed parts. A roller type cone bending attachment is a standard feature that is placed on the lower roll housing. All RMT plate rolls also include a safety wire surrounding the machine to automatically shut off the machine if necessary.





R-GIANT

R-GIANT

HYDRAULIC RECTILINEAR TYPE FOUR ROLL BENDING MACHINE

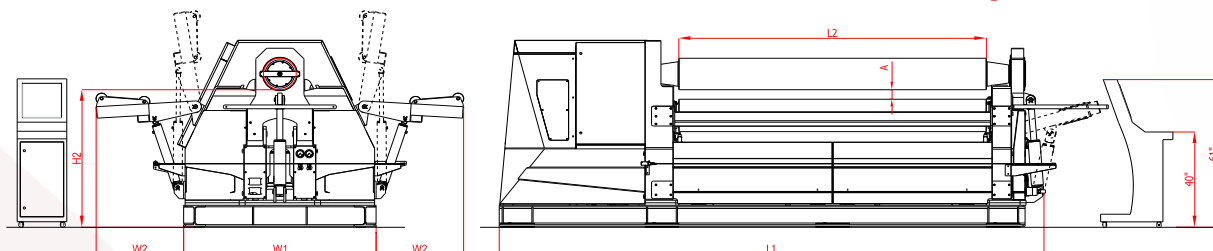

MODEL	Bending Length L2 (inch)	Min. Int. Dia Ø Dmin			Top Roll Ød (inch)	Bottom Roll Ø (inch)	Side Rolls Ø (inch)	Max. Pass Through A (inch)	Length L1 (inch)	Width W (inch)	Height H1 (inch)	Working Height H2 (inch)	Width of Side Support W2 (inch)	Weight (Lbs)	Motor Power (HP)	Min. Additional top roll diameter Ø (inch)	Hydraulic Tank Capacity l (Gal)
		Pre-Bending Capacity t (inch)	Bending Capacity Ødx4	Bending Capacity Ødx5													
R-GIANT 6-1811	6' 8"	1-1/2"	2"	2-1/4"	18.11	17.32	14.17	4"	183	90	94	70	54	52,470	60+30	16.93	220
R-GIANT 6-1890	6' 8"	2"	2-1/2"	2-3/4"	18.90	17.91	14.57	3-1/2"	183	90	94	70	54	54,675	75+30	16.93	220
R-GIANT 8-1811	8' 4"	1-3/8"	1-1/2"	1-3/4"	18.11	17.32	14.17	4"	203	90	94	70	54	58,202	45+30	16.93	220
R-GIANT 8-1890	8' 4"	1-1/2"	2"	2-1/4"	18.90	17.91	14.57	3-1/2"	203	90	94	70	54	70,989	60+30	16.93	220
R-GIANT 8-2126	8' 4"	2"	2-3/8"	2-1/2"	21.26	20.47	16.54	5-3/4"	218	104	110	81	62	93,696	50+50	19.69	290
R-GIANT 10-1811	10' 2"	1-3/16"	1-3/8"	1-1/2"	18.11	17.32	14.17	4"	224	90	94	70	54	69,446	50+30	16.93	220
R-GIANT 10-1890	10' 2"	1-3/8"	1-1/2"	1-3/4"	18.90	17.91	14.57	3-1/2"	224	90	94	70	54	77,162	60+30	16.93	220
R-GIANT 10-2047	10' 2"	1-1/2"	2"	2-1/4"	20.47	19.69	16.14	6-1/2"	240	104	110	81	62	99,208	40+40	19.69	290
R-GIANT 10-2283	10' 2"	1-3/4"	2-3/8"	2-1/2"	22.83	22.05	17.32	4"	240	104	110	80	62	110,231	50+50	19.69	290
R-GIANT 10-2559	10' 2"	2"	2-3/4"	3"	25.59	24.02	19.69	6"	251	128	145	112	71	158,733	60+60	24.80	450
R-GIANT 10-2992	10' 2"	2-3/4"	3-1/2"	3-1/2"	29.92	28.35	23.62	7-1/2"	280	150	169	132	71	242,508	75+75	28.74	580
R-GIANT 12-1811	12' 1"	1"	1-3/16"	1-5/16"	18.11	17.32	14.17	3-1/2"	284	91	100	74	54	85,980	50	16.93	220
R-GIANT 12-1890	12' 1"	1-1/8"	1-3/8"	1-1/2"	18.90	17.91	14.57	3-1/2"	264	90	94	70	54	94,799	50+30	16.93	220
R-GIANT 12-2047	12' 1"	1-3/16"	1-1/2"	1-5/8"	20.47	19.69	16.14	6-1/2"	279	104	110	81	62	110,231	40+40	19.69	290
R-GIANT 14-1811	14' 1"	3/4"	1"	1-1/8"	18.11	17.32	14.17	3-1/2"	284	91	100	74	54	85,980	50	16.93	220
R-GIANT 14-1890	14' 1"	1-1/8"	1-3/16"	1-5/16"	18.90	17.91	14.57	3-1/2"	264	90	94	70	54	94,799	50+30	16.93	220
R-GIANT 14-2047	14' 1"	1-1/8"	1-3/8"	1-1/2"	20.47	19.69	16.14	6-1/2"	279	104	110	81	62	110,231	40+40	19.69	290

The mentioned values above is only works for 38 KSI yield point material
 Different material types and plate widths ; can be calculated with RMT Roll Bending Calculator
 Conical bending capacities depends on cone angle and half value of mentioned values above.
 Weight and motor powers may increase with optional features.
 Due to ongoing product development, specifications may change at any time

Larger or Custom
Machines Available



RMT Double knuckle side support
with lip aligner

R-GIANT



STANDARD

- Rectilinear type side roll movement.
- PLC Electronic Balancing System
- Cone bending
- Induction hardened rolls (HRC 54-58)
- Polished rolls
- Single speed control of all axis
- Dual speed control of all axis (NC machines)
- Variable speed control of all axis (CNC machines)
- AISI 1050 Carbon steel rolls machined by CNC Lathes with optimal crown (special crown upon request)
- Automatic rolls peripheral speed compensation (optimum distribution of torque)
- Machine body constructed of stress-relieved high-yield steel
- Rolls seated in dual spherical bearings
- Hydraulic tiltable top roll and bracket (drop end) with easy pull out system
- Top and bottom rolls driven with hydraulic motor and planetary gear box
- Emergency stop wire around the machine
- Electrical and hydraulic protection against overloads
- World standard electrical and hydraulic components (parts stocked by RMT or available off-the-shelf from your local supplier)
- Adjustable hydraulic pressure on bottom roll (crowning compensation)
- Mobile control panel
- Manual lubrication
- Welding possibility on the machine

OPTIONAL

- NC Unit (Simple CNC)
- CNC Control Unit with color graphical control
- AISI 4140 High strength alloy steel rolls
- Four rolls drive
- Wired or wireless remote control
- Oil cooler
- Oil heater
- Side support system (both sides)
- Vertical hydraulic overhead support system 6, 8, 15 TON (10' - 14' - 16' - 20' tall)
- Preparation for side or vertical support system
- NC inclusion for vertical support control (Available on CNC control)
- NC inclusion for side support control (Available on CNC control)
- Plate alignment unit
- Automation system
- Changeable top roll for smaller diameter
- Special roll crowning
- Special plate support systems
- Automatic central lubrication
- Material feeding table (Idle or motorized)
- Separated power cabin



R-HYBRID VARIABLE GEOMETRY HYDRAULIC THREE ROLLS



BENDING THICK PLATES?

The variable-geometry plate rolls, which really operates more like a press brake than a traditional plate roll, makes not only extreme rolling possible, but much simpler. The two lower rolls are very similar to an adjustable V die, and the top roll can be operated like the ram of a press brake.

That is why we called this machine R-HYBRID. They are suitable for medium and thick plate bending.

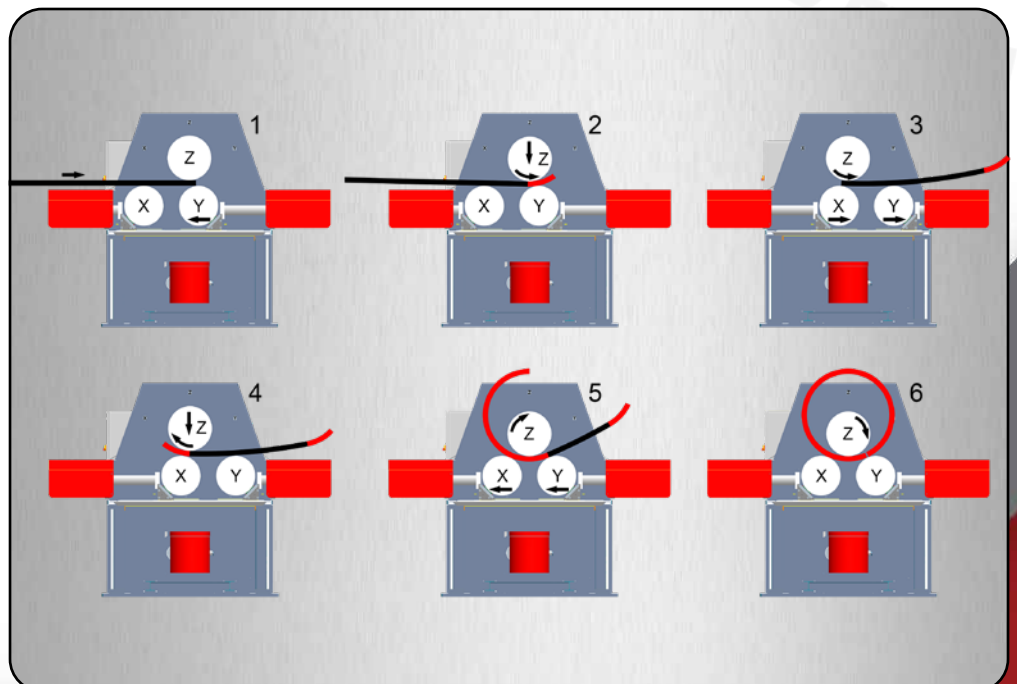

PRE-BENDING ADVANTAGE

Position of the rolls for the pre-bending execution on the first edge of the plate. The right lateral roll supports the plate, while the left one works like a lower mold.

The top roll pushes directly on the first side of the plate deforming it according to the required radius. The top roll through its thrust force pushes the plate against the left lateral roll that, being displaced in respect to the top roll, allows the first side of the plate to get deformed. The bigger the top roll thrust is, the lower the flat-end and the plate bending radius are.

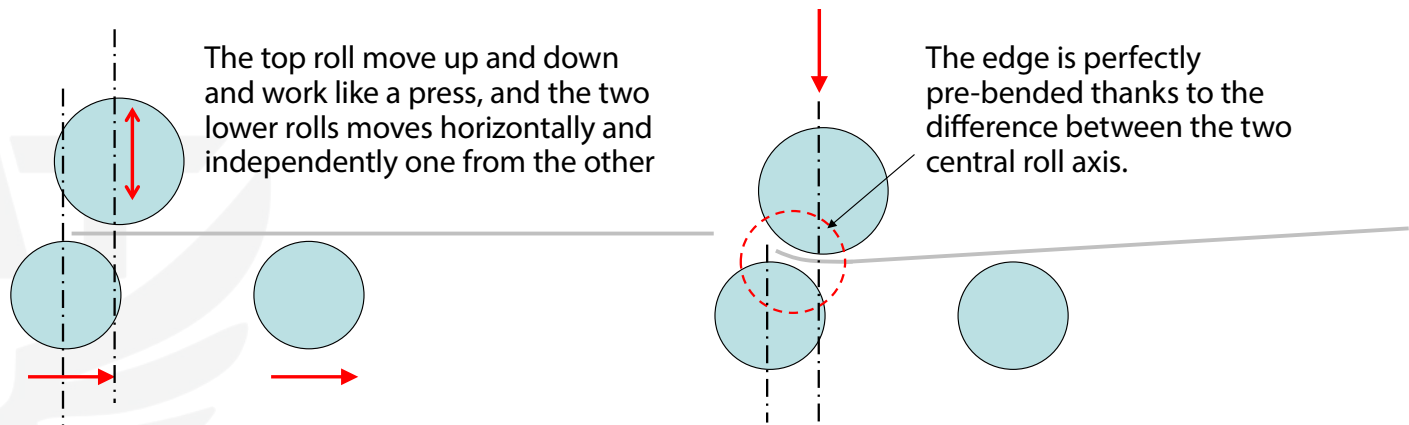

The pre-bending is performed by the top roll pushing directly against the first side of the plate, leaving a very short or null flat-end; the following rotation increases the curved initial side of the plate.





CALIBRATION AFTER THE WELDING

Another important feature of the R-HYBRID plate roll, is the press like system of the top forming roll. In fact, the top forming roll can be used as a traditional press allowing perfect re-rolling operation and calibration of thick plates. In the same way it is also possible to obtain cones with heavy thicknesses by bending the plate with several strokes.

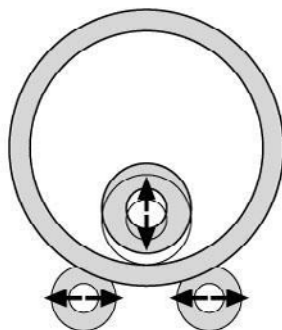
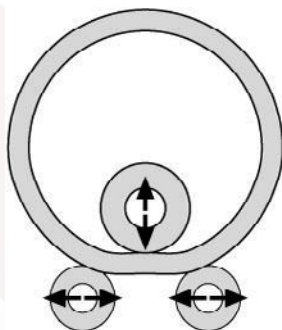

CONE BENDING

R-HYBRID plate rolls ability to tilt all 3 Axis allow for the best and easiest production of conical shapes. Material blank also moves linear through the machine and not radial as on 4 rolls and traditional 3 rolls

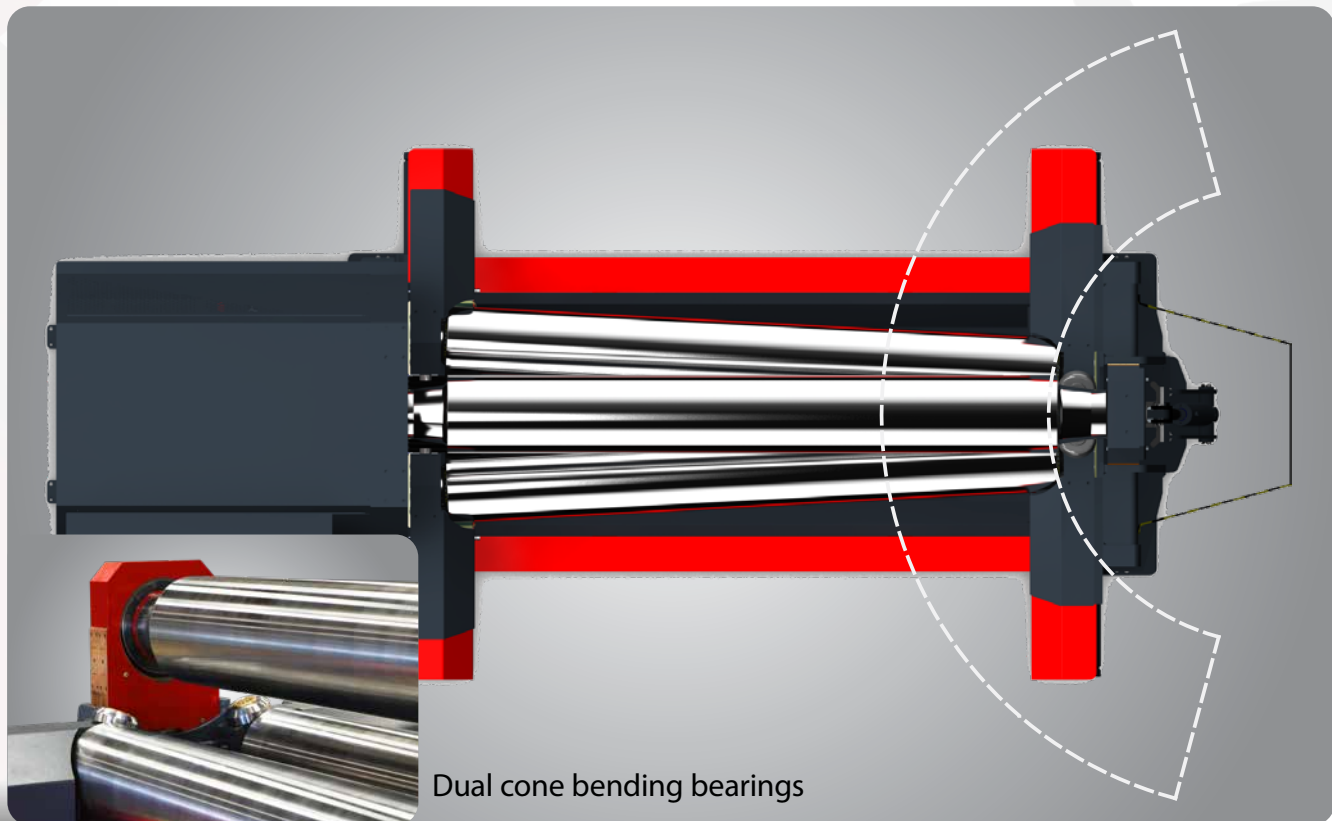

Dual cone bending bearings



VARIABLE-GEOMETRY PLATE ROLLS TACKLE UNBELIEVABLY THICK PLATE

RMT-Seravasi heavy plate roll technology has grown to never seen before bend thickness capability. Machine pits are deeper, the frames more massive, the rolls ever larger. Certain machines have specifications stating they can roll plate of certain yield strengths to 4, 6, and 7, even 11 inches cold. Vessel designs that would have been forged just a decade ago are now being sent to fabrication houses. RMT R-HYBRID rolls, which really operates more like a press brake than a traditional plate roll, is making such extreme rolling possible.





R-HYBRID

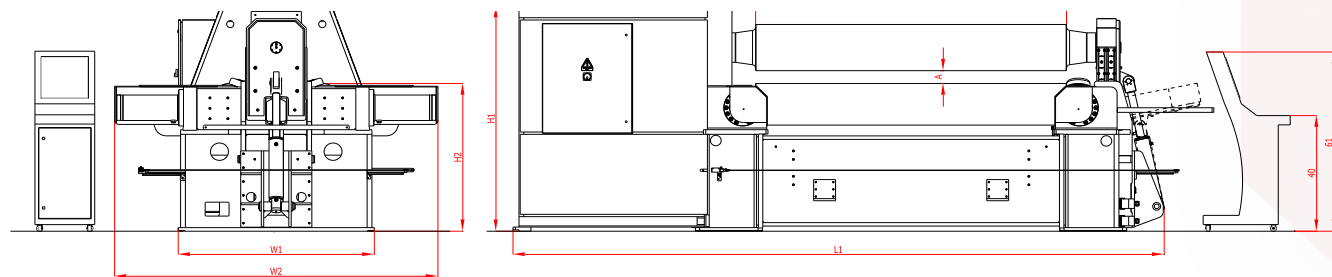

MODEL TYPE	Bending Length L2 (inch)	Min. Int. Dia Ø Dmin			Top Roll Ød (inch)	Lower Rolls Ø (inch)	Top Roll Bending Force US Tons	Max. Pass Through A (inch)	Length L1 (inch)	Width W1 (inch)	Total Width W2 (inch)	Height H1 (inch)	Working Height H2 (inch)	Weight (Lbs)	Main Motor (HP)	Hydraulic Tank Capacity (l)
		Pre-Bending Capacities t (inch)	Pre-Bending Capacities t (inch)	Bending Capacities T (inch)												
		Ødx1,5	Ødx5	Ødx5												
R-HYBRID 8-1377	8' 6"	3/4"	7/8"	1-1/8"	13.77"	12.99"	187	4"	192"	65"	106"	77"	49"	36,486	40	106
R-HYBRID 8-1575	8' 6"	1"	1 3/16"	1 9/16"	15.75"	14.17"	231	4"	215"	65"	106"	77"	50"	40,786	50	106
R-HYBRID 8-1772	8' 6"	1 3/16"	1 7/16"	1 7/8"	17.72"	16.54"	286	4-3/4"	220"	73"	114"	86"	57"	51,147	60	159
R-HYBRID 8-1969	8' 6"	1 3/8"	1 5/8"	2 5/32"	19.69"	18.11"	352	5-3/8"	228"	78"	121"	94"	61"	67,241	75	198
R-HYBRID 8-2205	8' 6"	1 9/16"	1 7/8"	2 3/8"	22.05"	19.69"	484	6"	238"	89"	139"	105"	69"	93,696	60+25	238
R-HYBRID 10-1377	10' 2"	5/8"	3/4"	1"	13.77"	12.99"	176	4"	214"	65"	106"	77"	49"	39,792	40	106
R-HYBRID 10-1575	10' 2"	3/4"	7/8"	1-1/8"	15.75"	14.17"	220	4"	234"	65"	106"	77"	50"	44,092	50	106
R-HYBRID 10-1772	10' 2"	1"	1 3/16"	1 5/8"	17.72"	16.54"	286	4-3/4"	240"	73"	114"	86"	57"	55,116	60	159
R-HYBRID 10-1969	10' 2"	1 3/16"	1 3/8"	1 7/8"	19.69"	18.11"	352	5-3/8"	248"	78"	121"	94"	61"	72,753	75	198
R-HYBRID 10-2205	10' 2"	1 3/8"	1 5/8"	2 5/32"	22.05"	19.69"	484	6"	258"	89"	139"	105"	69"	99,208	60+25	238
R-HYBRID 10-2440	10' 2"	2"	2 1/2"	3"	24.40"	22.04"	616	7"	354"	111"	173"	78"	118"	143,000	60+60	238
R-HYBRID 10-2677	10' 2"	2 1/2"	3"	3 1/2"	26.77"	23.62"	880	8"	362"	114"	178"	80"	120"	165,000	75+75	238
R-HYBRID 12-1377	12' 1"	1/2"	5/8"	1"	13.77"	12.99"	150	4"	238"	65"	106"	77"	49"	45,406	40	106
R-HYBRID 12-1575	12' 1"	5/8"	3/4"	1"	15.75"	14.17"	176	4"	274"	65"	106"	77"	50"	49,706	50	106
R-HYBRID 12-1772	12' 1"	3/4"	7/8"	1-1/8"	17.72"	16.54"	220	4-3/4"	280"	73"	114"	86"	57"	58,084	60	159
R-HYBRID 12-1969	12' 1"	1"	1 3/16"	1 9/16"	19.69"	18.11"	286	5-3/8"	287"	78"	121"	94"	61"	77,264	75	198
R-HYBRID 12-2205	12' 1"	1 1/8"	1 1/4"	1 3/4"	22.05"	19.69"	385	6"	297"	89"	139"	105"	69"	103,940	60+25	238
R-HYBRID 14-1377	14' 1"	3/8"	1/2"	3/4"	13.77"	12.99"	150	4"	262"	65"	106"	77"	49"	46,406	40	106
R-HYBRID 14-1575	14' 1"	1/2"	5/8"	1"	15.75"	14.17"	176	4"	274"	65"	106"	77"	50"	52,706	50	106
R-HYBRID 14-1772	14' 1"	3/4"	7/8"	1-1/8"	17.72"	16.54"	220	4-3/4"	280"	73"	114"	86"	57"	61,084	60	159
R-HYBRID 14-1969	14' 1"	1"	1 3/16"	1 9/16"	19.69"	18.11"	286	5-3/8"	287"	78"	121"	94"	61"	80,264	75	198
R-HYBRID 14-2205	14' 1"	1 1/8"	1 1/4"	1 3/4"	22.05"	19.69"	385	6"	297"	89"	139"	105"	69"	106,940	60+25	238

The mentioned values above is only works for 38 KSI yield point material.
 Different material types and plate widths ; can be calculated with RMT Roll Bending Calculator
 Conical bending capacities depends on cone angle and half value of mentioned values above.
 Weight and motor powers may increase with optional features.
 Due to ongoing product development, specifications may change at any time.

**Larger or Custom
Machines Available**



R-HYBRID - Planetary gearbox



R-HYBRID

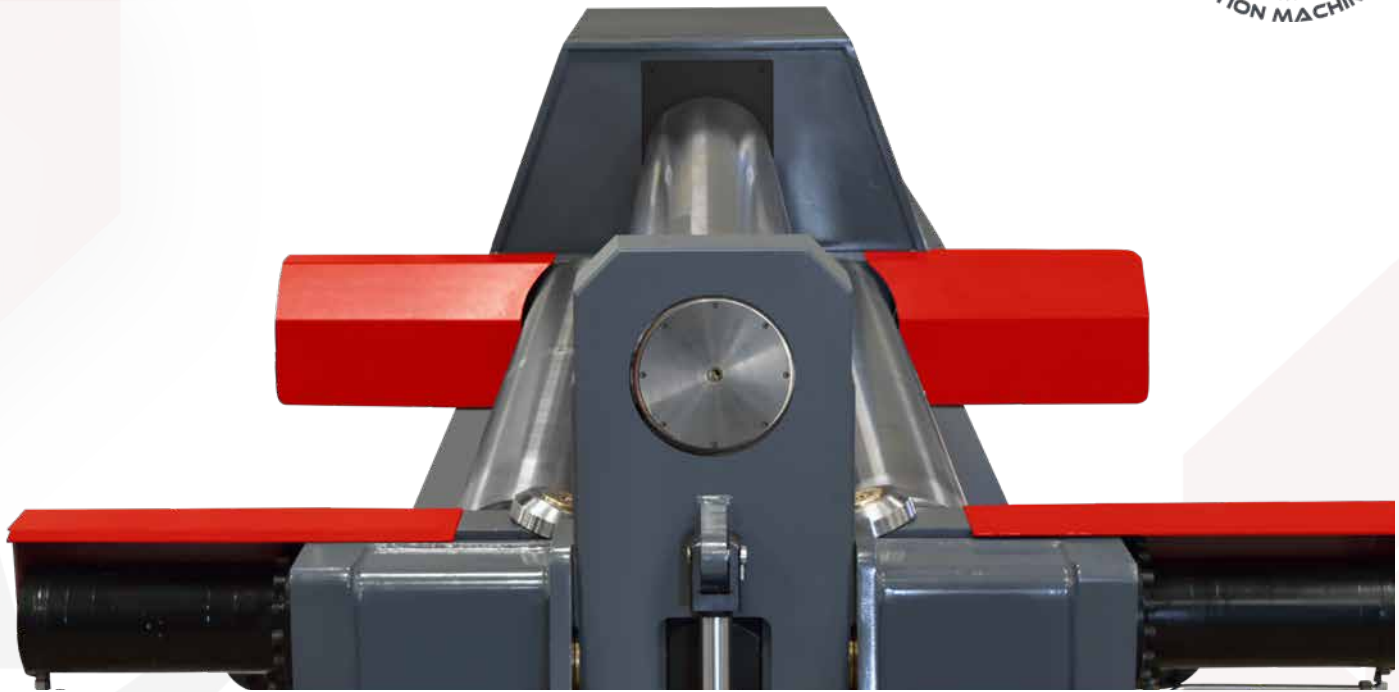

STANDARD

- Variable geometry type rolls movement.
- PLC control unit
- Dual speed
- Cone bending with dual cone bending roller bearing
- Induction hardened rolls (HRC 54-58)
- AISI 1050 Carbon steel rolls machined by CNC Lathes with optimal crown (special crown upon request)
- Polished rolls
- Top and lower rolls electronically positioned and synchronized with PLC and high-end precision digital scales
- High stroke top roll
- Braking system on side rolls
- Protected slide surfaces
- Machine body constructed of stress-relieved high-yield steel
- Rolls seated in spherical bearings
- Top roll hydraulic opening device (drop end) with easy pull out system
- Top roll driven with hydraulic motor and planetary gear box
- Safety barrier
- Electrical and hydraulic protection against overloads
- World standard electrical and hydraulic components (parts stocked by RMT or available off-the-shelf from your local supplier)
- Adjustable hydraulic pressure on bottom roll (crowning compensation)
- Mobile control panel
- Manual lubrication
- Welding possibility on the machine

OPTIONAL

- NC Control Unit
- All axis positioning with adjustable speed on NC machines
- AISI 4140 High strength alloy steel rolls
- Ground rolls
- Variable speed control
- Wired or wireless remote
- Oil cooler
- Oil heater
- Hydraulic side support system (both sides)
- Vertical overhead support system
- Preparation for vertical support system
- Material feeding table (Idle or motorized)
- Plate alignment unit
- Separated power cabin
- Changeable top roll for smaller Diameter
- Automatic central lubrications
- Automation system
- Special roll crowning
- Special applications for wind tower production



CUSTOM SOLUTIONS

AUTOMATIC LIQUID TANK BENDING LINES



CUSTOM SOLUTIONS



WIND TOWER BENDING LINES



PIPE BENDING SOLUTION





VERTICAL BENDING SOLUTIONS

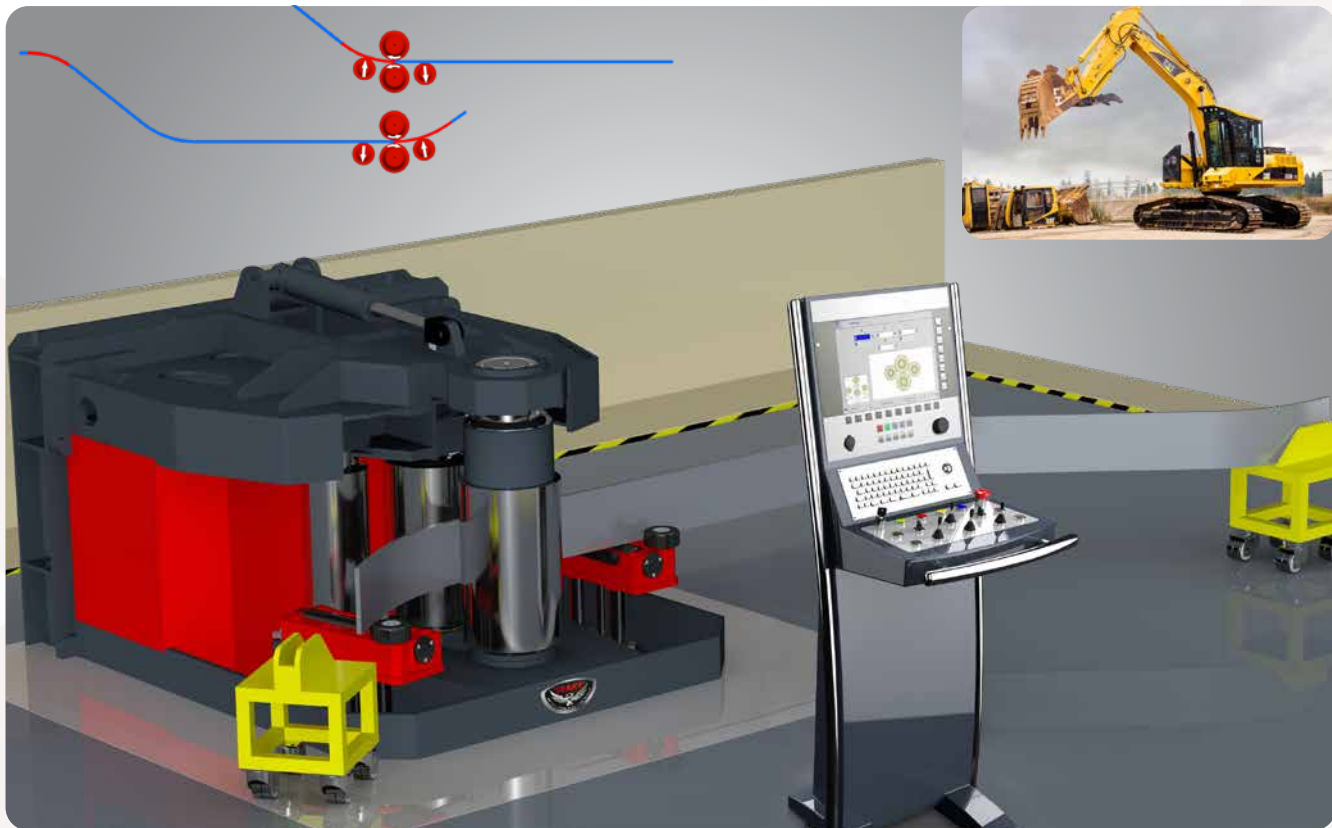

VERTICAL BENDING SOLUTIONS



AUTOMATIC VERTICAL COIL FEEDING, EDGE CUTTING, BENDING, WELDING SYSTEM



TRAFFIC BARRIER BENDING ROLL

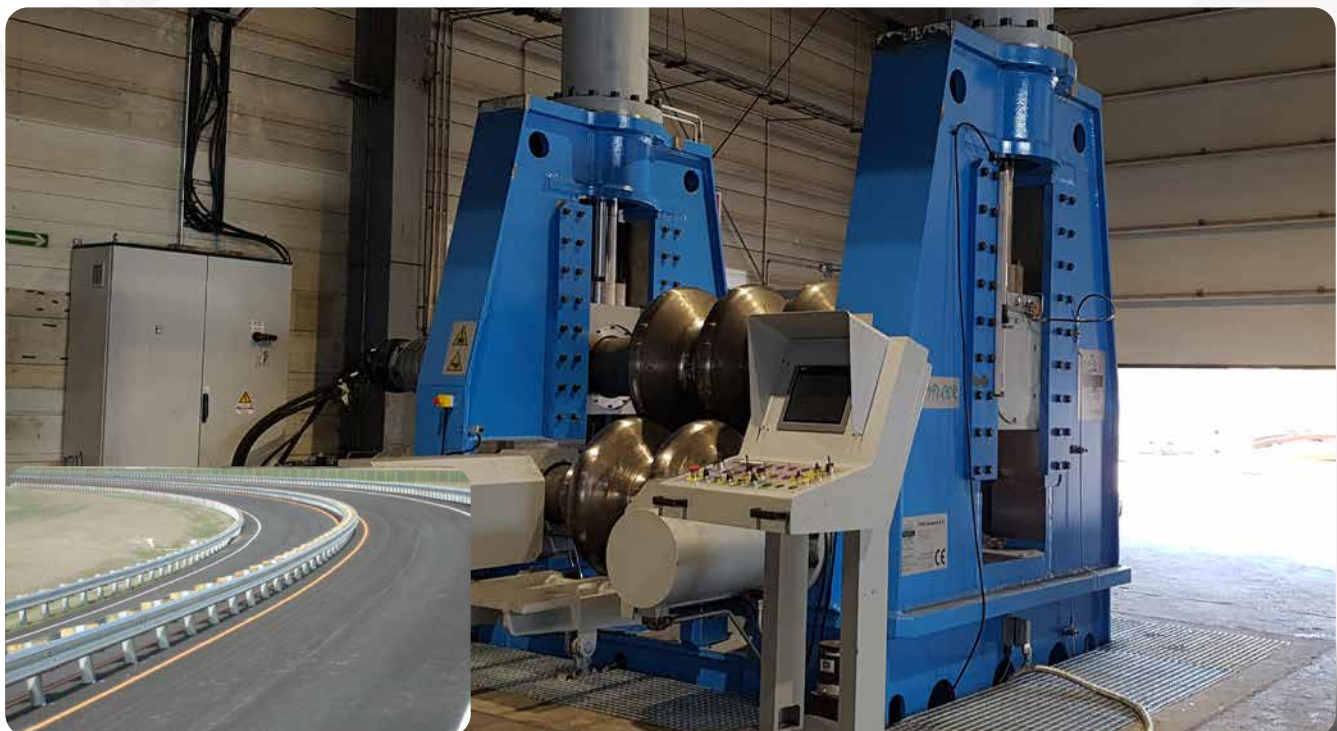



CORRUGATED SHEET BENDING MACHINE



SPACE ROCKET FUEL TANK BENDING MACHINE



Our team at RMT has developed some very unique / amazing solutions for the aerospace industry.

RETROFIT OLD MACHINES



BEFORE



1982 Roundo PS310



1977 Bertsch #30



2010 Imcar 4RH20

AFTER

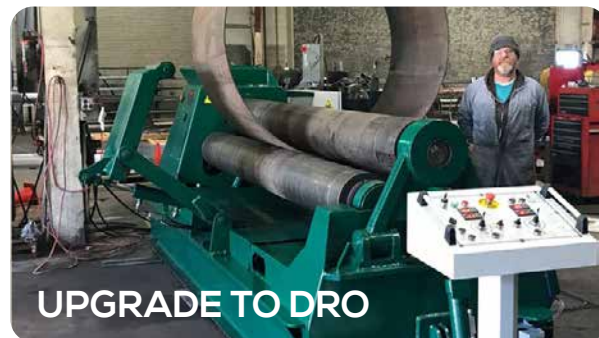

UPGRADE TO DRO



UPGRADE TO NC



UPGRADE TO CNC



EQUIVALENT CHART

Inches			Metric			Inches			Metric			Inches			Metric		
Fractional	Decimal	mm	Fractional	Decimal	mm	Fractional	Decimal	mm	Fractional	Decimal	mm	Fractional	Decimal	mm	Fractional	Decimal	mm
.	0.0039	0.1000	3/8	0.3750	9.5250	59/64	0.9219	23.4156	.	.	2.6378	67.0000
.	0.0079	0.2000	25/64	0.3906	9.9219	.	0.9252	23.5000	.	.	2.6772	68.0000
.	0.0118	0.3000	.	0.3937	10.0000	15/16	0.9375	23.8125	.	.	2.7165	69.0000
1/64	0.0156	0.3969	13/32	0.4063	10.3188	.	0.9449	24.0000	2 3/4	.	2.7500	69.8500
.	0.0157	0.4000	.	0.4134	10.5000	61/64	0.9531	24.2094	.	.	2.7559	70.0000
.	0.0197	0.5000	27/64	0.4219	10.7156	.	0.9646	24.5000	.	.	2.7953	71.0000
.	0.0236	0.6000	.	0.4331	11.0000	31/32	0.9688	24.6063	.	.	2.8346	72.0000
.	0.0276	0.7000	7/16	0.4375	11.1125	.	0.9843	25.0000	.	.	2.8740	73.0000
1/32	0.0313	0.7938	.	0.4528	11.5000	63/64	0.9844	25.0031	.	.	2.9134	74.0000
.	0.0315	0.8000	29/64	0.4531	11.5094	1	1.0000	25.4000	.	.	2.9528	75.0000
.	0.0354	0.9000	15/32	0.4688	11.9063	.	1.0039	25.5000	.	.	2.9921	76.0000
.	0.0394	1.0000	.	0.4724	12.0000	.	1.0236	26.0000	3	.	3.0000	76.2000
.	0.0433	1.1000	31/64	0.4844	12.3031	.	1.0433	26.5000	.	.	3.0315	77.0000
3/64	0.0469	1.1906	.	0.4921	12.5000	.	1.0630	27.0000	.	.	3.0709	78.0000
.	0.0472	1.2000	1/2	0.5000	12.7000	.	1.0827	27.5000	.	.	3.1102	79.0000
.	0.0512	1.3000	.	0.5118	13.0000	.	1.1024	28.0000	.	.	3.1496	80.0000
.	0.0551	1.4000	33/64	0.5156	13.0969	.	1.1220	28.5000	.	.	3.1890	81.0000
.	0.0591	1.5000	17/32	0.5313	13.4938	.	1.1417	29.0000	.	.	3.2283	82.0000
1/16	0.0625	1.5875	.	0.5315	13.5000	.	1.1614	29.5000	.	.	3.2677	83.0000
.	0.0630	1.6000	35/64	0.5469	13.8906	.	1.1811	30.0000	.	.	3.3071	84.0000
.	0.0669	1.7000	.	0.5512	14.0000	.	1.2205	31.0000	.	.	3.3465	85.0000
.	0.0709	1.8000	9/16	0.5625	14.2875	1 1/4	1.2500	31.7500	.	.	3.3858	86.0000
.	0.0748	1.9000	.	0.5709	14.5000	.	1.2598	32.0000	.	.	3.4252	87.0000
5/64	0.0781	1.9844	37/64	0.5781	14.6844	.	1.2992	33.0000	.	.	3.4646	88.0000
.	0.0787	2.0000	.	0.5906	15.0000	.	1.3386	34.0000	3 1/2	.	3.5000	88.9000
.	0.0827	2.1000	19/32	0.5938	15.0813	.	1.3780	35.0000	.	.	3.5039	89.0000
.	0.0866	2.2000	39/64	0.6094	15.4781	.	1.4173	36.0000	.	.	3.5433	90.0000
.	0.0906	2.3000	.	0.6102	15.5000	.	1.4567	37.0000	.	.	3.5827	91.0000
3/32	0.0938	2.3813	5/8	0.6250	15.8750	.	1.4961	38.0000	.	.	3.6220	92.0000
.	0.0945	2.4000	.	0.6299	16.0000	1 1/2	1.5000	38.1000	.	.	3.6614	93.0000
.	0.0984	2.5000	41/64	0.6406	16.2719	.	1.5354	39.0000	.	.	3.7008	94.0000
7/64	0.1094	2.7781	.	0.6496	16.5000	.	1.5748	40.0000	.	.	3.7402	95.0000
.	0.1181	3.0000	21/32	0.6563	16.6688	.	1.6142	41.0000	.	.	3.7795	96.0000
1/8	0.1250	3.1750	.	0.6693	17.0000	.	1.6535	42.0000	.	.	3.8189	97.0000
.	0.1378	3.5000	43/64	0.6719	17.0656	.	1.6929	43.0000	.	.	3.8583	98.0000
9/64	0.1406	3.5719	11/16	0.6875	17.4625	.	1.7323	44.0000	.	.	3.8976	99.0000
5/32	0.1563	3.9688	.	0.6890	17.5000	1 3/4	1.7500	44.4500	.	.	3.9370	100.0000
.	0.1575	4.0000	45/64	0.7031	17.8594	.	1.7717	45.0000	4	.	4.0000	101.6000
11/64	0.1719	4.3656	.	0.7087	18.0000	.	1.8110	46.0000	.	.	4.3307	110.0000
.	0.1772	4.5000	23/32	0.7188	18.2563	.	1.8504	47.0000	4 1/2	.	4.5000	114.3000
3/16	0.1875	4.7625	.	0.7283	18.5000	.	1.8898	48.0000	.	.	4.7244	120.0000
.	0.1969	5.0000	47/64	0.7344	18.6531	.	1.9291	49.0000	5	.	5.0000	127.0000
13/64	0.2031	5.1594	.	0.7480	19.0000	.	1.9685	50.0000	.	.	5.1181	130.0000
.	0.2165	5.5000	3/4	0.7500	19.0500	2	2.0000	50.8000	.	.	5.5118	140.0000
7/32	0.2188	5.5563	49/64	0.7656	19.4469	.	2.0079	51.0000	.	.	5.9055	150.0000
15/64	0.2344	5.9531	.	0.7677	19.5000	.	2.0472	52.0000	6	.	6.0000	152.4000
.	0.2362	6.0000	25/32	0.7813	19.8438	.	2.0866	53.0000	.	.	6.2992	160.0000
1/4	0.2500	6.3500	.	0.7874	20.0000	.	2.1260	54.0000	.	.	6.6929	170.0000
.	0.2559	6.5000	51/64	0.7969	20.2406	.	2.1654	55.0000	.	.	7.0866	180.0000
17/64	0.2656	6.7469	.	0.8071	20.5000	.	2.2047	56.0000	.	.	7.4803	190.0000
.	0.2756	7.0000	13/16	0.8125	20.6375	.	2.2441	57.0000	.	.	7.8740	200.0000
9/32	0.2813	7.1438	.	0.8268	21.0000	2 1/4	2.2500	57.1500	8	.	8.0000	203.2000
.	0.2953	7.5000	53/64	0.8281	21.0344	.	2.2835	58.0000	.	.	9.8425	250.0000
19/64	0.2969	7.5406	27/32	0.8438	21.4313	.	2.3228	59.0000	10	.	10.0000	254.0000
5/16	0.3125	7.9375	.	0.8465	21.5000	.	2.3622	60.0000	20	.	20.0000	508.0000
.	0.3150	8.0000	55/64	0.8594	21.8281	.	2.4016	61.0000	30	.	30.0000	762.0000
21/64	0.3281	8.3344	.	0.8661	22.0000	.	2.4409	62.0000	40	.	40.0000	1016.0000
.	0.3346	8.5000	7/8	0.8750	22.2250	.	2.4803	63.0000	60	.	60.0000	1524.0000
11/32	0.3438	8.7313	.	0.8858	22.5000	2 1/2	2.5000	63.5000	80	.	80.0000	2032.0000
.	0.3543	9.0000	57/64	0.8906	22.8219	.	2.5197	64.0000	100	.	100.0000	2540.0000
23/64	0.3594	9.1281	.	0.9055	23.0000	.	2.5591	65.0000
.	0.3740	9.5000	29/32	0.9063	23.0188	.	2.5984	66.0000

Gauge	Stainless		Galvanized		Sheet Steel		Aluminum	
	Fraction	inches (mm)	inches (mm)	inches (mm)	inches (mm)	inches (mm)	inches (mm)	inches (mm)
30		0.0125 (0.33)	0.0157 (0.40)	0.0120 (0.30)	0.0100 (0.25)			
29		0.0141 (0.36)	0.0172 (0.44)	0.0135 (0.34)	0.0113 (0.29)			
28	1/64	0.0156 (0.41)	0.0187 (0.47)	0.0149 (0.38)	0.0126 (0.32)			
27		0.0172 (0.43)	0.0202 (0.51)	0.0164 (0.42)	0.0142 (0.36)			
26		0.0187 (0.48)	0.0217 (0.55)	0.0179 (0.45)	0.0159 (0.40)			
25		0.0219 (0.56)	0.0247 (0.63)	0.0209 (0.53)	0.0179 (0.46)			
24		0.025 (0.64)	0.0276 (0.70)	0.0239 (0.61)	0.0201 (0.51)			
23		0.0281 (0.71)	0.0306 (0.78)	0.0269 (0.68)	0.0226 (0.58)			
22	1/32	0.0312 (0.79)	0.0336 (0.85)	0.0299 (0.76)	0.0253 (0.64)			
21		0.0344 (0.86)	0.0366 (0.93)	0.0329 (0.84)	0.0285 (0.71)			
20		0.0375 (0.95)	0.0396 (1.01)	0.0359 (0.91)	0.0320 (0.81)			
19		0.0437 (1.1)	0.0456 (1.16)	0.0418 (1.06)	0.0359 (0.91)			
18		0.0500 (1.27)	0.0516 (1.31)	0.0478 (1.21)	0.0403 (1.02)			
17		0.0562 (1.4)	0.0575 (1.46)	0.0538 (1.37)	0.0453 (1.1)			
16	1/16	0.0625 (1.59)	0.0635 (1.61)	0.0598 (1.52)	0.0508 (1.29)			
15		0.0703 (1.8)	0.0710 (1.80)	0.0673 (1.71)	0.0571 (1.4)			
14	5/64	0.0781 (1.98)	0.0785 (1.99)	0.0747 (1.90)	0.0641 (1.63)			
13	3/32	0.094 (2.4)	0.0934 (2.37)	0.0897 (2.28)	0.072 (1.8)			
12	7/64	0.1094 (2.78)	0.1084 (2.75)	0.1046 (2.66)	0.0808 (2.05)			
11	1/8	0.1250 (3.18)	0.1233 (3.13)	0.1196 (3.04)	0.0907 (2.30)			
10	9/64	0.1406 (3.57)	0.1382 (3.51)	0.1345 (3.42)	0.1019 (2.59)			
9	5/32	0.1563 (3.97)	0.1532 (3.89)	0.1495 (3.80)	0.1144 (2.91)			
8	11/64	0.1719 (4.37)	0.1681 (4.27)	0.1644 (4.18)	0.1285 (3.26)			
7	3/16	0.1875 (4.76)		0.1793 (4.55)	0.1443 (3.67)			
6	13/64	0.2031		0.1943 (4.94)	0.162 (4.1)			
5	7/32	0.2187		0.2092 (5.31)	0.1819			
4	15/64	0.2344		0.2242 (5.69)	0.2043			
3	1/4	0.25		0.2391 (6.07)	0.2294			

ASTM SPECIFICATIONS



V	DESCRIPTION	GRADE	TENSILE STRENGTH K.S.I.	YIELD STRENGTH K.S.I.
A-36	STRUCTURAL STEEL	-	60	36
A-131	STRUCTURAL STEEL FOR SHIPS	-	71	34
A-242	HIGH-STRENGTH LOW-ALLOY STRUCTURAL STEEL	-	70	50
A-283 GRADE A	LOW & INTERMEDIATE TENSILE STRENGTH CARBON STEEL PLATES OF STRUCTURAL QUALITY	A	55	24
A-283 GRADE B		B	60	27
A-283 GRADE C		C	65	30
A-283 GRADE D		D	72	33
A-285 GRADE A	LOW & INTERMEDIATE TENSILE STRENGTH CARBON STEEL PLATES FOR PRESSURE VESSEL	A	65	24
A-285 GRADE B		B	70	27
A-285 GRADE C		C	75	30
A-299	CARBON MANGANESE SILICON STEEL PLATE FOR PRESSURE VESSELS	-	95	42
A-514	HIGH-YIELD STRENGTH, QUENCHED AND TEMPERED ALLOY STEEL PLATE SUITABLE FOR WELDING	-	130	100
A-515 GRADE 55	CARBON STEEL PLATES FOR INTERMEDIATE AND HIGHER TEMPERATURE SERVICE FOR PRESSURE VESSELS	55	75	30
A-515 GRADE 60		60	80	32
A-515 GRADE 65		65	85	35
A-515 GRADE 70		70	90	38
A-516 GRADE 55	CARBON STEEL PLATES FOR MODERATE AND LOWER TEMPERATURE SERVICE FOR PRESSURE VESSELS	55	75	30
A-516 GRADE 60		60	80	32
A-516 GRADE 65		65	85	35
A-516 GRADE 70		70	90	38
A-517	HIGH STRENGTH, ALLOY STEEL QUENCHED AND TEMPERED PLATES FOR PRESSURE VESSEL	-	135	100
A-537 CLASS I	HEAT TREATED, CARBON MANGANESE-SILICON STEEL PLATE FOR PRESSURE VESSEL	CLASS I	90	50
A-537 CLASS II		CLASS II	100	60
A-572 GRADE 42	HIGH-STRENGTH LOW-ALLOY COLUMBIUM-VANADIUM STEELS OF STRUCTURAL QUALITY	42	60	42
A-572 GRADE 50		50	65	50
A-572 GRADE 60		60	75	60
A-572 GRADE 65		65	80	65
A-588	HIGH-STRENGTH LOW-ALLOY STRUCTURAL STEEL	ALL	70	50
A-606 H.R.	STRIP, HOT ROLLED AND COLD ROLLED, HIGH-STRENGTH, LOW-ALLOY WITH IMPROVED CORROSION RESISTANCE	H.R.	70	50
A-606 C.R.		C.R. ANNEAL. NORM.	65	45
A-633 GRADE A-B	NORMALIZED HIGH-STRENGTH LOW-ALLOY STRUCTURAL STEEL	A-B	83	42
A-633 GRADE C-D		C-D	90	50
A-633 GRADE E		E	100	60
A-656 GRADE 50	HOT-ROLLED STRUCTURAL STEEL, HIGH-STRENGTH LOW-ALLOY STEEL PLATE WITH IMPROVED FORMABILITY	50	60	50
A-656 GRADE 60		60	70	60
A-656 GRADE 70		70	80	70
A-656 GRADE 80		80	90	80
STAINLESS STEEL	302, 304, 304L, 316, & 316L	302, 304, 304L, 316, & 316L	90	54
ALUM. 3004-H34	3004-H34	3004-H34	35	21
ALUM. 5052-H32	5052-H32	5052-H32	33	28
ALUM. 6061-T6	6061-T6	6061-T6	42	37
Weldox 700	Weldox 700 is a general structural steel with a minimum yield strength of 95 - 100 Ksi depending on thickness. Typical applications are demanding loadbearing structures.		125	100
Weldox 900/960	Weldox 960 is a general structural steel with a minimum yield strength of 120 - 140 Ksi depending on thickness. Typical applications are demanding loadbearing structures.		155	140
Weldox 1100	Weldox 1100 is a general structural steel with a minimum yield strength of 160 Ksi. Typical applications are demanding loadbearing structures.		195	160
Hardox 400	Hardox 400 is the wear resistant steel for combined payload and service life solutions.		185	145
Hardox 450	450 is an abrasion resistant steel with a nominal hardness of 450 HBW. Typical applications are components and structures subject to wear.		205	175
Hardox 500	Hardox 500 is an abrasion resistant steel with a nominal hardness of 500 HBW. Typical applications are components and structures subject to wear.		225	185

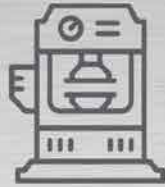

Hydraulic Presses

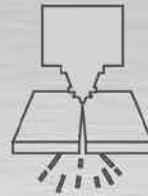

Fiber Lasers

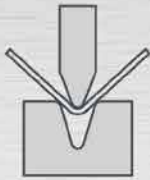

Press Brakes

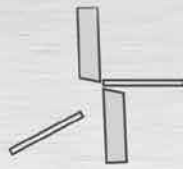

Shears

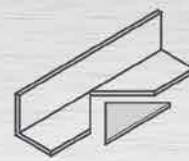

Ironworkers

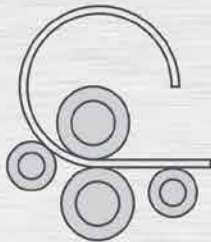
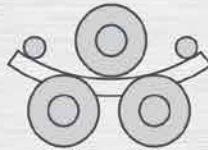
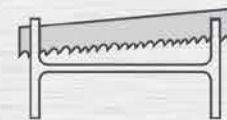

Plate Rolls



Angle Rolls



Bandsaws

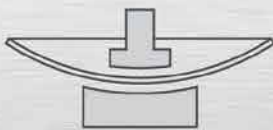

Dishing Presses

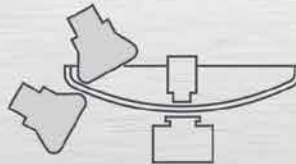

Flanging Machines

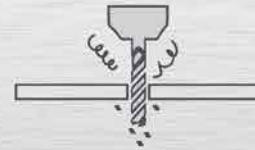

Drilling Machines

*"If you need a machine and don't buy it, you'll find that you have paid for it anyway, but don't have it."
Henry Ford*

Revolution Machine Tools
385 N 700 W
North Salt Lake, UT 84054

www.RMTUS.com
info@rmtus.com

Phone: 844.RMT.INFO
844.768.4636

KYSON

844-768-4636 / www.RMTUS.com